

## Floor Scale

 <p>KPZ 1SX /</p>	 <p>KPZ 1S /</p>	 <p>KPZ 1BS /</p>
 <p>KPZ 2SX /</p>	 <p>KPZ 2S /</p>	 <p>KPZ 2ECO /</p>
 <p>KPZ 2B /</p>	 <p>KPZ 2D /</p>	 <p>KPZ 2 DIA Wheel chair scales </p>
 <p>KPZ 2-08-2 Dual Counting System</p>	 <p>KPZ 2ECOW / laundry scale</p>	 <p>KPZ 2E07</p>
		<p>Animal Scale</p> 
		

**Special models are our speciality!**

## Container scale

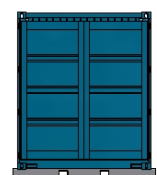
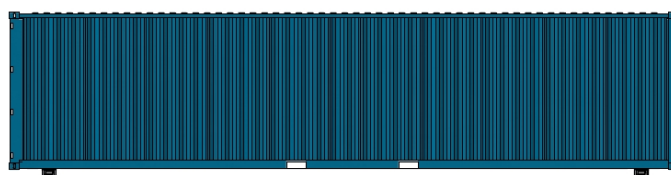

## KPZ 2SX / Platform scale

**Solid floor scales up to 3.000 kg for industrial use**







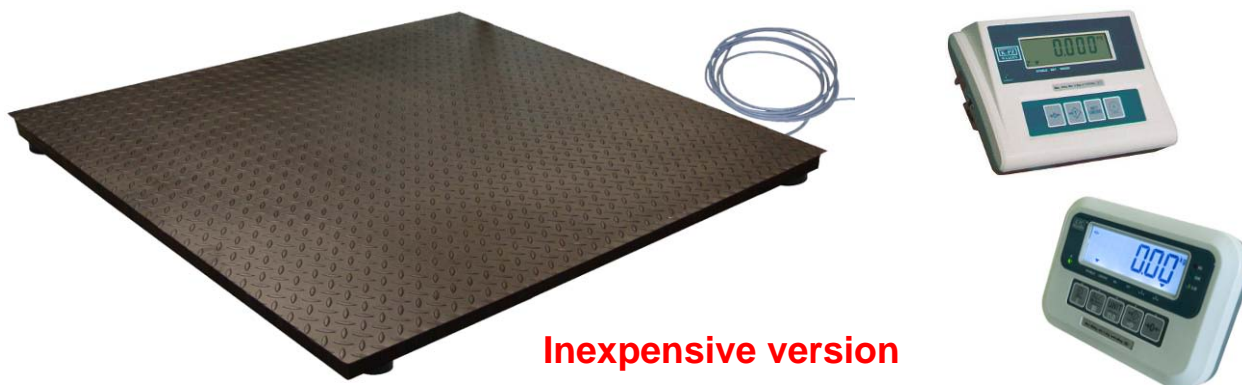

















**Weights & measures | powder coating | good value for money | solid**

**Possible to deliver without Indicator or OEM-Version**

**USA Version Page 7**



**Inexpensive version**

Typ	Capacity	Div.	Dim. mm.	Approval possibility	Indicator	PLN/pc	Art.-No
KPZ 2X	1500/3000	500/1000	1000 x 1000 x 100	YES  	<b>without</b>	On Request	2SX010103000
KPZ 2X	1500/3000	500/1000	1250 x 1250 x 100	YES  	<b>without</b>	On Request	2SX012123000
KPZ 2X	1500/3000	500/1000	1250 x 1500 x 100	YES  	<b>without</b>	On Request	2SX012153000
KPZ 2X	1500/3000	500/1000	1500 x 1500 x 100	YES  	<b>without</b>	On Request	2SX015153000
KPZ 2X	1500/3000	500/1000	1000 x 1000 x 100	No	KPZ 5218	On Request	2SXM10103000
KPZ 2X	1500/3000	500/1000	1250 x 1250 x 100	No	KPZ 5218	On Request	2SXM12123000
KPZ 2X	1500/3000	500/1000	1250 x 1500 x 100	No	KPZ 5218	On Request	2SXM12153000
KPZ 2X	1500/3000	500/1000	1500 x 1500 x 100	No	KPZ 5218	On Request	2SXM15153000
KPZ 2XE	3000	1000	1000 x 1000 x 100	YES  	KPZ 52E8	On Request	2SXE1010300E
KPZ 2XE	3000	1000	1250 x 1250 x 100	YES  	KPZ 52E8	On Request	2SXE1212300E
KPZ 2XE	3000	1000	1250 x 1500 x 100	YES  	KPZ 52E8	On Request	2SXE1215300E
KPZ 2XE	3000	1000	1500 x 1500 x 100	YES  	KPZ 52E8	On Request	2SXE1515300E
KPZ 2XEM	1500/3000	500/1000	1000 x 1000 x 100	YES  	KPZ 52E8	On Request	2SXM1010300E
KPZ 2XEM	1500/3000	500/1000	1250 x 1250 x 100	YES  	KPZ 52E8	On Request	2SXM1212300E
KPZ 2XEM	1500/3000	500/1000	1250 x 1500 x 100	YES  	KPZ 52E8	On Request	2SXM1215300E
KPZ 2XEM	1500/3000	500/1000	1500 x 1500 x 100	YES  	KPZ 52E8	On Request	2SXM1515300E

Solid and stable platform scales series KPZ 2SX. German design and own EU production guarantees high quality. Designed as floor scales, industrial weighing. High accuracy. Maintenance-free durable steel construction. Powder paint coated.

**Construction:** Robust, maintenance-free, welded steel construction, heavy duty design for industrial use, non-slip finish weighing platform, durable black powder coat.

**Load cells:** Robust, nickel-plated load cell, IP68, OIML, with a high overload capacity.

**Installation:** Adjustable leveling feet, designed for permanent or portable installations, 5m cable to connect digital indicator.

**Options:** Extra ramps, Base anchors, Wall mounting for indicator, Indicator stand, Custom sizes and capacities

**Standard indicator:** KPZ 52-18

**For approved applications:** KPZ 52E-8

**Options for indicators:** Multi range, RS 232 serial interface, Various printers connection, Radio data transfer, WLAN, etc.. Internal battery

**Approvals:** OIML class III , CE conform

**Power Supply :** 230 V mains, Power cord

**Special requirements for unique loading - please contact us for more information!**

## Special models are our speciality!

## KPZ 2S / Platform scale

**Rugged floor scale up to 20.000 kg for industrial use**

**For continuous operation**

**Better quality: We use only EU approved components !!!**

**Maintenance free**

**Long service life**

**Robust**

**Inexpensive**

**Mobile**



### Options:



Options: Please contact us, we will do almost everything for you.

**(Pharmaceutical version on request)**

**Weighing range from 0 up to 20.000 kg**

Solid and stable platform scales series KPZ 2S. German design and own EU production guarantees high quality. Designed as floor scales, industrial weighing. High accuracy. Maintenance-free durable steel construction. Powder paint coated.

**Construction:** Robust, maintenance-free, welded steel construction, heavy duty design for industrial use, non-slip finish weighing platform, durable black powder coat.

**Load cells:** Robust, nickel-plated load cell, IP68, OIML, with a high overload capacity.

**Installation:** Adjustable leveling feet, designed for permanent or portable installations, 5m cable to connect digital indicator.

**Options:** Extra ramps, Base anchors, Wall mounting for indicator, Indicator stand, Custom sizes and capacities

**Standard indicator:** KPZ 52-18

**For approved applications:** KPZ 52E-8

**Options for indicators:** Multi range, RS 232 serial interface, Various printers connection, Radio data transfer, WLAN, etc.. Internal battery

**Approvals:** OIML class III , CE conform

**Power Supply :** 230 V mains, Power cord

**Special requirements for unique loading - please contact us for more information!**

**Platform scale KPZ 2**, high quality industrial platform, long service life, solid and stable steel construction black powder painted, structured plate. **Load cells:** High quality load cells DMS type KPZ 502E-3, IP67, OIML C3. **Indicator:** KPZ 52E-8 (possibility to deliver without indicator), 16ft cable, sheltered at way out of scale in case of mechanical damage. **Certification:** EC approval possibility class III, Declaration of Conformity.

**Construction:** steel, welded frame made of profile with diagonal reinforcement and solid structured plate, black powder painted (option: galvanized or stainless construction). Indicator connection cable: length 16ft. Special flat construction is suitable for ground placing. With regard to solid DMS load cells there are no wearing out parts.

**Weighing system:** 4 high quality DMS load cells KPZ 502E-3, IP67, EC approval possibility class III.

**Approvals:** OIML class III , CE conform

**Power Supply :** 230 V mains, Power cord

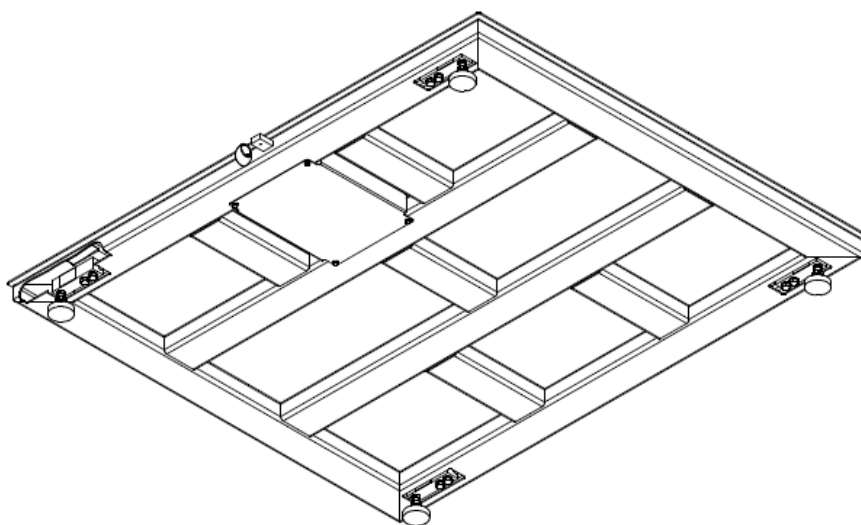

















KPZ quality construction e.g.: KPZ 2S : 1250x1500 mm

**KPZ price includes complete scale with indicator.**

**Special models are our speciality!**



Typ	Capacity	Div.	Dim. mm.	Approval possibility	Indicator	PLN/pc	Art.-No
KPZ 2JE	300 kg	100 g	800 x 800 x 95	YES	52E8	On Request	2SJ00808030E
KPZ 2JM	150/300 kg	50/100 g	800 x 800 x 95	No	5218	On Request	2SJM08080300
KPZ 2JE	600 kg	200 g	800 x 800 x 95	YES	52E8	On Request	2SJ00808060E
KPZ 2J	300/600 kg	100/200 g	800 x 800 x 95	No	5218	On Request	2SJM08080600
KPZ 2JME	600/1200 kg	200/500 g	800 x 800 x 95	YES	52E8	On Request	2SJM0808120E
KPZ 2JM	600/1200 kg	200/500 g	800 x 800 x 95	No	5218	On Request	2SJM08081200
KPZ 2JE	1500 kg	500 g	800 x 800 x 95	YES	52E8	On Request	2SJ00808150E
KPZ 2J	1500 kg	500 g	800 x 800 x 95	No	5218	On Request	2SJ008081500
KPZ 2JE	2000 kg	1000 g	800 x 800 x 95	YES	52E8	On Request	2SJ00808200E
KPZ 2J	2000 kg	1000 g	800 x 800 x 95	No	5218	On Request	2SJ008082000
KPZ 2JM	1000/2000 kg	200/500 g	800 x 800 x 95	No	5218	On Request	2SJM08082000
KPZ 2JME	1500/3000 kg	500/1000 g	800 x 800 x 95	YES	52E8	On Request	2SJM0808300E
KPZ 2JM	1500/3000 kg	500/1000 g	800 x 800 x 95	No	5218	On Request	2SJM08083000
KPZ 2JE	300 kg	100 g	1000 x 1000 x 95	YES	52E8	On Request	2SJ01010030E
KPZ 2JM	150/300 kg	50/100 g	1000 x 1000 x 95	No	5218	On Request	2SJM10100300
KPZ 2JE	600 kg	200 g	1000 x 1000 x 95	YES	52E8	On Request	2SJ01010060E
KPZ 2J	300/600 kg	100/200 g	1000 x 1000 x 95	No	5218	On Request	2SJ010100600
KPZ 2JME	600/1200kg	200/500 g	1000 x 1000 x 95	YES	52E8	On Request	2SJM1010120E
KPZ 2JM	600/1200kg	200/500 g	1000 x 1000 x 95	No	5218	On Request	2SJM10101200
KPZ 2JE	1500 kg	500 g	1000 x 1000 x 95	YES	52E8	On Request	2SJ01010150E
KPZ 2J	1500 kg	500 g	1000 x 1000 x 95	No	5218	On Request	2SJ010101500
KPZ 2JE	2000 kg	1000 g	1000 x 1000 x 95	YES	52E8	On Request	2SJ01010200E
KPZ 2J	2000 kg	1000 g	1000 x 1000 x 95	No	5218	On Request	2SJ010102000
KPZ 2JM	1000/2000 kg	200/500 g	1000 x 1000 x 95	No	5218	On Request	2SJM10102000
KPZ 2JME	1500/3000 kg	500/1000 g	1000 x 1000 x 95	YES	52E8	On Request	2SJM1010300E
KPZ 2JM	1500/3000 kg	500/1000 g	1000 x 1000 x 95	No	5218	On Request	2SJM10103000
KPZ 2JE	600kg	200 g	1250 x 830 x 95	YES	52E8	On Request	2SJ01208060E
KPZ 2J	600kg	200 g	1250 x 830 x 95	No	5218	On Request	2SJ012080600
KPZ 2JME	600/1200kg	200/500 g	1250 x 830 x 95	YES	52E8	On Request	2SJM1208120E
KPZ 2JM	600/1200kg	200/500 g	1250 x 830 x 95	No	5218	On Request	2SJM12081200
KPZ 2JE	1500 kg	500 g	1250 x 830 x 95	YES	52E8	On Request	2SJ01208150E
KPZ 2J	1500 kg	500 g	1250 x 830 x 95	No	5218	On Request	2SJ012081500
KPZ 2JE	2000 kg	1000 g	1250 x 830 x 95	YES	52E8	On Request	2SJ01208200E
KPZ 2J	2000 kg	1000 g	1250 x 830 x 95	No	5218	On Request	2SJ012082000
KPZ 2JM	1000/2000 kg	200/500 g	1250 x 830 x 95	No	5218	On Request	2SJM12082000
KPZ 2JME	1500/3000kg	500/1000 g	1250 x 830 x 95	YES	52E8	On Request	2SJM1208300E
KPZ 2JM	1500/3000kg	500/1000 g	1250 x 830 x 95	No	5218	On Request	2SJM12083000
KPZ 2JE	600kg	200 g	1250 x 1000 x 95	YES	52E8	On Request	2SJ01210060E
KPZ 2J	600kg	200 g	1250 x 1000 x 95	No	5218	On Request	2SJ012100600
KPZ 2JME	600/1200kg	200/500g	1250 x 1000 x 95	YES	52E8	On Request	2SJM1210120E
KPZ 2JM	600/1200kg	200/500g	1250 x 1000 x 95	No	5218	On Request	2SJM12101200
KPZ 2JE	1500 kg	500 g	1250 x 1000 x 95	YES	52E8	On Request	2SJ01210150E
KPZ 2J	1500 kg	500 g	1250 x 1000 x 95	No	5218	On Request	2SJ012101500
KPZ 2JE	2000 kg	1000 g	1250 x 1000 x 95	YES	52E8	On Request	2SJ01210200E
KPZ 2J	2000 kg	1000 g	1250 x 1000 x 95	No	5218	On Request	2SJ012102000
KPZ 2JM	1000/2000 kg	200/500 g	1250 x 1000 x 95	No	5218	On Request	2SJM12102000
KPZ 2JME	1500/3000 kg	500/1000 g	1250 x 1000 x 95	YES	52E8	On Request	2SJM1210300E
KPZ 2JME	1500/3000 kg	500/1000 g	1250 x 1000 x 95	No	5218	On Request	2SJM12103000
KPZ 2JE	600 kg	200 g	1250 x 1250 x 95	YES	52E8	On Request	2SJ01212060E
KPZ 2J	600 kg	200 g	1250 x 1250 x 95	No	5218	On Request	2SJ012120600
KPZ 2JME	600/1200 kg	200/500 g	1250 x 1250 x 95	YES	52E8	On Request	2SJM1212120E
KPZ 2JM	600/1200 kg	200/500 g	1250 x 1250 x 95	No	5218	On Request	2SJM12121200
KPZ 2JE	1500 kg	500 g	1250 x 1250 x 95	YES	52E8	On Request	2SJ01212150E
KPZ 2J	1500 kg	500 g	1250 x 1250 x 95	No	5218	On Request	2SJ012121500
KPZ 2JE	2000 kg	1000 g	1250 x 1250 x 95	YES	52E8	On Request	2S001212200E
KPZ 2JE	2000 kg	1000 g	1250 x 1250 x 95	No	5218	On Request	2SJ012122000
KPZ 2JM	1000/2000 kg	200/500 g	1250 x 1250 x 95	No	5218	On Request	2SJM12122000
KPZ 2JME	1500/3000 kg	500/1000 g	1250 x 1250 x 95	YES	52E8	On Request	2SJM1212300E
KPZ 2JME	1500/3000 kg	500/1000 g	1250 x 1250 x 95	No	5218	On Request	2SJM12123000

Typ	Capacity	Div.	Dim. mm.	Approval possibility	Indicator	PLN/pc	Art.-No
KPZ 2JE	600 kg	200 g	1250 x 1500 x 95	YES 	52E8	On Request	2SJ01215060E
KPZ 2J	600 kg	200 g	1250 x 1500 x 95	No	5218	On Request	2SJ012150600
KPZ 2JME	600/1200kg	200/500g	1250 x 1500 x 95	YES 	52E8	On Request	2SJM1215120E
KPZ 2JM	600/1200kg	200/500g	1250 x 1500 x 95	No	5218	On Request	2SJM12151200
KPZ 2JE	1500 kg	500 g	1250 x 1500 x 95	YES 	52E8	On Request	2SJ01215150E
KPZ 2J	1500 kg	500 g	1250 x 1500 x 95	No	5218	On Request	2SJ012151500
KPZ 2JE	2000 kg	1000 g	1250 x 1500 x 95	YES 	52E8	On Request	2SJ01215200E
KPZ 2J	2000 kg	1000 g	1250 x 1500 x 95	No	5218	On Request	2SJ012152000
KPZ 2JM	1000/2000 kg	200/500 g	1250 x 1500 x 95	No	5218	On Request	2SJM12152000
KPZ 2JME	1500/3000 kg	500/1000 g	1250 x 1500 x 95	YES 	52E8	On Request	2SJM1215300E
KPZ 2JM	1500/3000 kg	500/1000 g	1250 x 1500 x 95	No	5218	On Request	2SJM12153000
KPZ 2JE	1500 kg	500 g	1500 x 1500 x 95	YES 	52E8	On Request	2SJ01515150E
KPZ 2J	1500 kg	500 g	1500 x 1500 x 95	No	5218	On Request	2SJ015151500
KPZ 2JE	2000 kg	1000 g	1500 x 1500 x 95	YES 	52E8	On Request	2SJ01515200E
KPZ 2J	2000 kg	1000 g	1500 x 1500 x 95	No	5218	On Request	2SJ015152000
KPZ 2JM	1000/2000 kg	200/500 g	1500 x 1500 x 95	No	5218	On Request	2SJM15152000
KPZ 2JME	1500/3000 kg	500/1000 g	1500 x 1500 x 95	YES 	52E8	On Request	2SJM1515300E
KPZ 2JM	1500/3000 kg	500/1000 g	1500 x 1500 x 95	No	5218	On Request	2SJM15153000
KPZ 2E	6000 kg	2000 g	1500 x 1500 x 165	YES 	52E8	On Request	2S001515600E
KPZ 2JE	1500 kg	500 g	1500 x 2000 x 130	YES 	52E8	On Request	2SJ01520150E
KPZ 2J	1500 kg	500 g	1500 x 2000 x 130	No	5218	On Request	2SJ015201500
KPZ 2JE	2000 kg	1000 g	1500 x 2000 x 130	YES 	52E8	On Request	2SJ01520200E
KPZ 2J	2000 kg	1000 g	1500 x 2000 x 130	No	5218	On Request	2SJ015202000
KPZ 2JME	1500/3000 kg	500/1000 g	1500 x 2000 x 130	YES 	52E8	On Request	2SJM1520300E
KPZ 2JM	1500/3000 kg	500/1000 g	1500 x 2000 x 130	No	5218	On Request	2SJM15203000
KPZ 2E	6000 kg	2000 g	1500 x 2000 x 165	YES 	52E8	On Request	2S001520600E
KPZ 2JE	1500 kg	500 g	2000 x 2000 x 130	YES 	52E8	On Request	2SJ02020150E
KPZ 2J	1500 kg	500 g	2000 x 2000 x 130	No	5218	On Request	2SJ020201500
KPZ 2JE	2000 kg	1000 g	2000 x 2000 x 130	YES 	52E8	On Request	2SJ02020200E
KPZ 2J	2000 kg	1000 g	2000 x 2000 x 130	No	5218	On Request	2SJ020202000
KPZ 2JME	1500/3000 kg	500/1000 g	2000 x 2000 x 130	YES 	52E8	On Request	2SJM2020300E
KPZ 2JM	1500/3000 kg	500/1000 g	2000 x 2000 x 130	No	5218	On Request	2SJM20203000
KPZ 2E	6000 kg	2000 g	2000 x 2000 x 165	YES 	52E8	On Request	2S002020600E

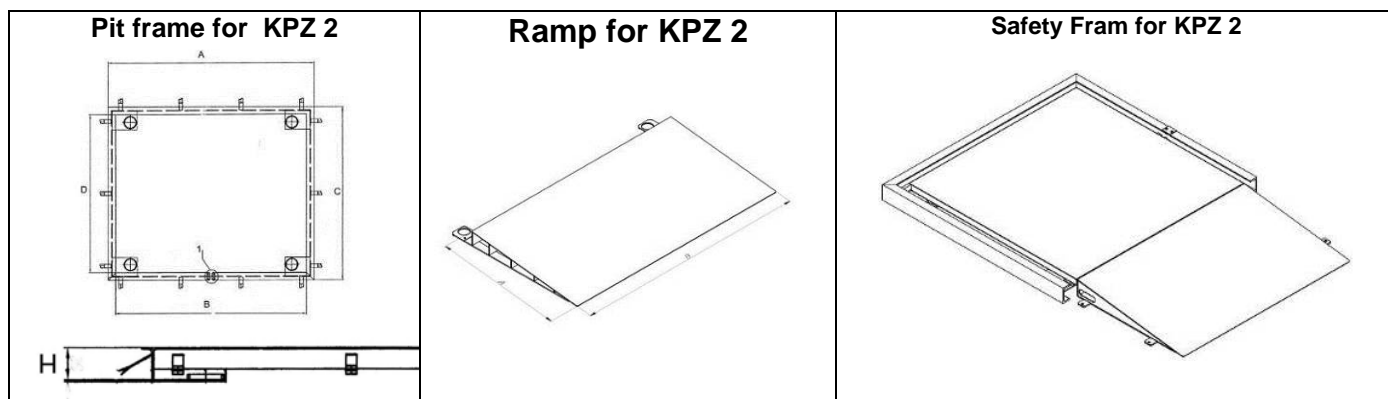

## USA Version

Typ	Capacity lb / kg	Division lb / g	Dim. ft / mm	Approval possible	Indicator	Price \$	Article-No.
KPZ 2E	1000 lb / 450 kg	0.2lb/ 90 g	2x 2 / 610x610	YES	52E8		2SE02020100L
KPZ 2M	500/1000 lb / 255/450 kg	0.1/0.2 lb/ 45/90 g	2x 2 / 610x610	No	5218		2SM02020100L
KPZ 2E	2000 lb/ 900 kg	0.5 lb / 225 g	2x 2 / 610x610	YES	52E8		2SE02020200L
KPZ 2	1000/2000 lb/450/900 kg	0.2/0.5 lb/ 90/225 g	2x 2 / 610x610	No	5218		2SM02020200L
KPZ 2E	5000 lb/ 2260 kg	1 lb / 450 g	2x 2 / 610x610	YES	52E8		2SE02020500L
KPZ 2	2500/5000 lb /1130/2260 kg	0.5/1 lb / 225/450 g	2x 2 / 610x610	No	5218		2SM02020500L
KPZ 2E	1000 lb/ 450 kg	0.2lb/ 90 g	3x 3 / 915x915	YES	52E8		2SE03030100L
KPZ 2M	500/1000 lb/ 255/450 kg	0.1/0.2 lb/ 45/90 g	3x 3 / 915x915	No	5218		2SM03030100L
KPZ 2E	2000 lb/900 kg	0.5 lb / 225 g	3x 3 / 915x915	YES	52E8		2SE03030200L
KPZ 2	1000/2000 lb/ 450/900 kg	0.2/0.5 lb/ 90/225 g	3x 3 / 915x915	No	5218		2SM03030200L
KPZ 2E	5000 lb / 2260 kg	1 lb / 450 g	3x 3 / 915x915	YES	5218		2SE03030500L
KPZ 2	2500/5000 lb/ 1130/2260 kg	0.5/1 lb / 225/450 g	3x 3 / 915x915	No	5218		2SM03030500L
KPZ 2E	2000 lb/ 900 kg	0.5 lb/ 225 g	4x 4 / 1220x1220	YES	52E8		2SE04040200L
KPZ 2	1000/2000 lb/450/900 kg	0.2/0.5 lb / 90/225 g	4x 4 / 1220x1220	No	5218		2SM04040200L
KPZ 2E	5000 lb / 2260 kg	1 lb/ 450 g	4x 4 / 1220x1220	YES	5218		2SE04040500L
KPZ 2	2500/5000 lb/ 1130/2260 kg	0.5/1 lb / 225/450 g	4x 4 / 1220x1220	No	5218		2SM04040500L
KPZ 2E	6500 lb / 2950 kg	2 lb/ 900 g	4x 4 / 1220x1220	YES	5218		2SE04040650L
KPZ 2	3750/6500 lb/1475/2950 kg	1/2 lb/ 450/900 g	4x 4 / 1220x1220	No	5218		2SM04040650L
KPZ 2E	2000 lb / 900 kg	0.5 lb/ 225 g	4x 5 / 1220x1520	YES	52E8		2SE04050200L
KPZ 2	1000/2000 lb / 450/900 kg	0.2/0.5 lb / 90/225 g	4x 5 / 1220x1520	No	5218		2SM04050200L
KPZ 2E	5000 lb/ 2260 kg	1 lb/ 450 g	4x 5 / 1220x1520	YES	5218		2SE04050500L
KPZ 2	2500/5000 lb /1130/2260 kg	0.5/1 lb / 225/450 g	4x 5 / 1220x1520	No	5218		2SM04050500L
KPZ 2E	6500 lb / 2950 kg	2 lb/ 900 g	4x 5 / 1220x1520	YES	5218		2SE04050650L
KPZ 2	3750/6500 lb/ 1475/2950 kg	1/2 lb/ 450/900 g	4x 5 / 1220x1520	No	5218		2SM04050650L
KPZ 2E	2000 lb/ 900 kg	0.5 lb/ 225 g	4x 6 / 1220x1820	YES	52E8		2SE04060200L
KPZ 2	1000/2000 lb/ 450/900 kg	0.2/0.5 lb / 90/225 g	4x 6 / 1220x1820	No	5218		2SM04060200L
KPZ 2E	5000 lb/ 2260 kg	1 lb/ 450 g	4x 6 / 1220x1820	YES	5218		2SE04060500L
KPZ 2	2500/5000 lb/ 1130/2260 kg	0.5/1 lb / 225/450 g	4x 6 / 1220x1820	No	5218		2SM04060500L
KPZ 2E	6500 lb/ 2950 kg	2 lb/ 900 g	4x 6 / 1220x1820	YES	5218		2SE04060650L
KPZ 2	3750/6500 lb/ 1475/2950 kg	1/2 lb/ 450/900 g	4x 6 / 1220x1820	No	5218		2SM04060650L
KPZ 2E	2000 lb / 900 kg	0.5 lb/ 225 g	5x 5 / 1520x1520	YES	52E8		2SE05050200L
KPZ 2	1000/2000 lb/ 450/900 kg	0.2/0.5 lb / 90/225 g	5x 5 / 1520x1520	No	5218		2SM05050200L
KPZ 2E	5000 lb / 2260 kg	1 lb/ 450 g	5x 5 / 1520x1520	YES	5218		2SE05050500L
KPZ 2	2500/5000 lb / 1130/2260 kg	0.5/1 lb / 225/450 g	5x 5 / 1520x1520	No	5218		2SM05050500L
KPZ 2E	6500 lb/ 2950 kg	2 lb/ 900 g	5x 5 / 1520x1520	YES	52E8		2SE05050650L
KPZ 2	3750/6500 lb / 1475/2950 kg	1/2 lb/ 450/900 g	5x 5 / 1520x1520	No	5218		2SM05050650L
KPZ 2E	10000 lb / 4545 kg	2 lb/ 900 g	5x 5 / 1520x1520	No	5218		2SE05051000L
KPZ 2	5000/10000 lb/2260/4545 kg	1/2 lb/ 450/900 g	5x 5 / 1520x1520	YES	52E8		2SM05051000L
KPZ 2E	2000 lb / 900 kg	0,5 lb/ 225 g	5x 7 / 1520x2120	YES	52E8		2SE05070200L
KPZ 2	1000/2000 lb / 450/900 kg	0.2/0.5 lb / 90/225 g	5x 7 / 1520x2120	No	5218		2SM05070200L
KPZ 2E	5000 lb/ 2260 kg	1 lb/ 450 g	5x 7 / 1520x2120	YES	5218		2SE05070500L
KPZ 2	2500/5000 lb/ 1130/2260 kg	0.5/1 lb / 225/450 g	5x 7 / 1520x2120	No	5218		2SM05070500L
KPZ 2E	6500 lb/ 2950 kg	2 lb/ 900 g	5x 7 / 1520x2120	YES	5218		2SE05070650L
KPZ 2	3750/6500 lb / 1475/2950 kg	1/2 lb/ 450/900 g	5x 7 / 1520x2120	No	5218		2SM05070650L
KPZ 2E	10000 lb/ 4545 kg	2 / 900	5x 7 / 1520x2120	No	5218		2SE05071000L
KPZ 2	5000/10000 lb/ 2260/4545 kg	1/2 / 450/900	5x 7 / 1520x2120	YES	52E8		2SM05071000L



<b>Options / accessories / extra charge</b>	<b>PLN/pc</b>	<b>Article-Nr</b>
Pit frame for KPZ 2 , Steel, 800 x 800 mm up to 3t	On Request	25S008083000
Pit frame for KPZ 2 , Steel, 830 x 1250 mm up to 3t	On Request	25S008123000
Pit frame for KPZ 2 , Steel, 1000 x 1000 mm up to 3t	On Request	25S010103000
Pit frame for KPZ 2 , Steel, 1000 x 1250 mm up to 3t	On Request	25S010123000
Pit frame for KPZ 2 , Steel, 1250 x 1250 mm up to 3t	On Request	25S012123000
Pit frame for KPZ 2 , Steel, 1250 x 1500 mm up to 3t	On Request	25S012153000
Pit frame for KPZ 2 , Steel, 1500 x 1500 mm up to 3t	On Request	25S015153000
Pit frame for KPZ 2 , Steel, 1500 x 1500 mm 6t	On Request	25S015156000
Pit frame for KPZ 2 , Steel 1500 x 2000 mm up to 3t	On Request	25S015203000
Pit frame for KPZ 2 , Steel, 1500 x 2000 mm 6t	On Request	25S015206000
Pit frame for KPZ 2 , Steel, 2000 x 2000 mm up to 3t	On Request	25S020203000
Pit frame for KPZ 2 , Steel, 2000 x 2000 mm 6t	On Request	25S020206000

<b>Ramp for KPZ 2</b>			
<b>Fits</b>	<b>Ramp dimension</b>	<b>PLN/pc</b>	<b>Article-Nr</b>
KPZ 2 800 x 800 mm up to 3t	800 mm wide, 800 mm long	On Request	21S008083000
KPZ 2 830 x 1250 mm up to 3t	830 mm wide, 800 mm long	On Request	21S008093000
KPZ 2 1000 x 1000 mm up to 3t	1000 mm wide, 800 mm long	On Request	21S008103000
KPZ 2 1000 x 1250 mm up to 3t	1000 mm wide, 800 mm long	On Request	21S008103000
KPZ 2 1250 x 1250 mm up to 3t	1250 mm wide, 800 mm long	On Request	21S008123000
KPZ 2 1250 x 1500 mm up to 3t	1250 mm wide, 800 mm long	On Request	21S008123000
KPZ 2 1500 x 1500 mm up to 3t	1500 mm wide, 800 mm long	On Request	21S008153000
KPZ 2 1500 x 1500 mm up to 6t	1500 mm wide, 1500 mm long	On Request	21S015156000
KPZ 2 1500 x 2000 mm up to 3t	1500 mm wide, 1500 mm long	On Request	21S015153000
KPZ 2 1500 x 2000 mm up to 6t	1500 mm wide, 1500 mm long	On Request	21S015156000
KPZ 2 2000 x 2000 mm up to 3t	2000 mm wide, 1500 mm long	On Request	21S015203000
KPZ 2 2000 x 2000 mm up to 6t	2000 mm wide, 1500 mm long	On Request	21S015206000

<b>Packing dimension</b>		
<b>Model</b>	<b>scale capacity</b>	<b>packing dimension</b>
KPZ 2 800 x 800	Up to 3000kg	80 x 120 x 50 cm , 80 kg
KPZ 2 1000 x 1000	Up to 3000kg	130 x 100 x 50 cm, 100 kg
KPZ 2 1250 x 1250	Up to 3000kg	130 x 135 x 50 cm 135 kg
KPZ 2 1250 x 1500	Up to 3000kg	130 x 160 x 50 cm. 160 kg
KPZ 2 1500 x 1500	Up to 3000kg	160 x 160 x 50 cm 190 kg
KPZ 2 1500 x 2000	Up to 3000kg	160 x 200 x 50 cm 330 kg
KPZ 2 1500 x 2000	Up to 6000kg	160 x 200 x 50 cm 385 kg
KPZ 2 2000 x 2000	Up to 6000kg	200 x 200 x 50 cm 490 kg

**Special models are our speciality!**



## KPZ 2S ECO / Platform scale

**Solid floor scales up to 800 kg for Standard use**

**Weights & measures | galvanic Frame | Alumin Top plate | solid**

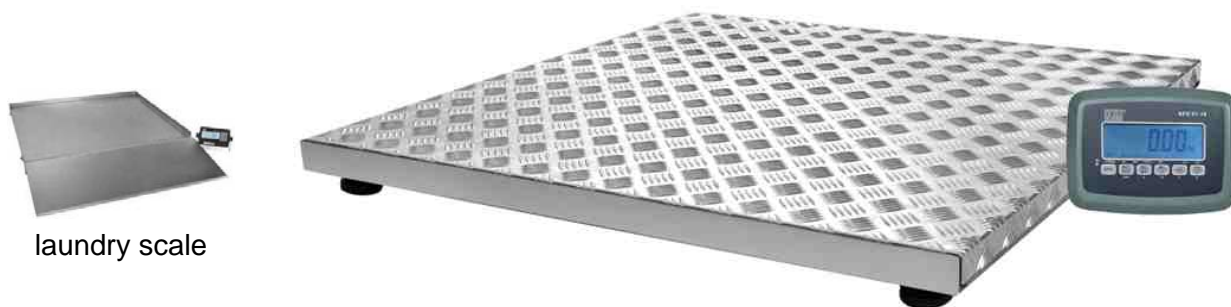

laundry scale

Solid and stable platform scales series KPZ 2ECO. German design and own EU production guarantees high quality. Designed as floor scales, industrial weighing. High accuracy. Maintenance-free durable steel construction. Powder paint coated.

**Construction:** Robust, maintenance-free, welded steel construction, heavy duty design for industrial use, non-slip finish Aluminw eighing platform, durable black powder coat.

**Load cells:** Robust, nickel-plated load cell, IP68, OIML, with a high overload capacity.

**Installation:** Adjustable leveling feet, designed for permanent or portable installations, 5m cable to connect digital indicator.

**Options:** Extra ramps, Base anchors, Wall mounting for indicator, Indicator stand, Custom sizes and capacities















**Standard indicator:** KPZ 52-18

**For approved applications:** KPZ 52E-8

**Options for indicators:** Multi range, RS 232 serial interface, Various printers connection, Radio data transfer, WLAN, etc.. Internal battery

**Approvals:** OIML class III , CE conform

**Power Supply :** 230 V mains, Power cord

Type	Capacity	Division	Indicator	Approval possible	Dim. mm	PLN/pc	Article-No.
KPZ 2 EKO	150/300 kg	50/100 g	KPZ 52-18	No	580 x 1010 x 85	On Request	2VA006100300
KPZ 2 EKO	300 kg	100 g	KPZ 52E-8	Yes  	580 x 1010 x 85	On Request	2VA00610030E
KPZ 2 EKO	150/300 kg	50/100 g	KPZ 52-18	No	910 x 1010 x 85	On Request	2VA009100300
KPZ 2 EKO	300 kg	100 g	KPZ 52E-8	Yes  	910 x 1010 x 85	On Request	2VA00910030E
KPZ 2 EKO	150/300 kg	50/100 g	KPZ 52-18	No	740 x 1260 x 85	On Request	2VA007120300
KPZ 2 EKO	300 kg	100 g	KPZ 52E-8	Yes  	740 x 1260 x 85	On Request	2VA00712030E
KPZ 2 EKO	150/300 kg	50/100 g	KPZ 52-18	No	1160 x 1260 x 85	On Request	2VA010120300
KPZ 2 EKO	300 kg	100 g	KPZ 52E-8	Yes  	1160 x 1260 x 85	On Request	2VA01012030E
KPZ 2 EKO	150/300 kg	50/100 g	KPZ 52-18	No	510 x 1510 x 85	On Request	2VA005150300
KPZ 2 EKO	300 kg	100 g	KPZ 52E-8	Yes  	510 x 1510 x 85	On Request	2VA00515030E
KPZ 2 EKO	150/300 kg	50/100 g	KPZ 52-18	No	670x1510x85	On Request	2VA006150300
KPZ 2 EKO	300 kg	100 g	KPZ 52E-8	Yes  	670x1510x85	On Request	2VA00615030E
KPZ 2 EKO	150/300 kg	50/100 g	KPZ 52-18	No	660 x 1810 x 85	On Request	2VA007180300
KPZ 2 EKO	300 kg	100 g	KPZ 52E-8	Yes  	660 x 1810 x 85	On Request	2VA00718030E

### KPZ 2 EKO

#### Packing dimension

Type	scale capacity	packing dimension
KPZ 2EKO 580 x 1010 x 85	Up to 300kg	80 x 120 x 50 cm, 40 kg
KPZ 2EKO 910 x 1010 x 85	Up to 300kg	100 x 120 x 50 cm, 50 kg
KPZ 2EKO 740 x 1260 x 85	Up to 300kg	80 x 120 x 50 cm, 50 kg
KPZ 2EKO 1160 x 1260 x 85	Up to 300kg	125 x 125 x 50 cm, 65 kg
KPZ 2EKO 510 x 1510 x 85	Up to 300kg	80 x 160 x 50 cm, 50 kg
KPZ 2EKO 670x1510x 85	Up to 300kg	80 x 160 x 50 cm, 55 kg
KPZ 2EKO 660 x 1810 x 85	Up to 300kg	80 x 185 x 50 cm, 60 kg

**Special models are our speciality!**

## KPZ 2B / Barrel Frame scale

Solid floor scales up to 1.000 kg for industrial use

Weights & measures | powder coating | good value for money | solid



Typ	Capacity	Division	Indicator	Approval possible	Dim. mm	PLN/pc	Article-No
KPZ 2B	400 kg	100 g	KPZ 52-18	No	600 x 600 x 95	On Request	2BS006060400
<b>KPZ 2BM</b>	<b>300/600kg</b>	<b>100/200g</b>	<b>KPZ 52-18</b>	<b>No</b>		On Request	<b>2BSM06060600</b>
KPZ 2B	600 kg	200 g	KPZ 52-18	No		On Request	2BS006060600
KPZ 2B	600 kg	200 g	KPZ 52E-8	Yes 		On Request	2BS00606060E
<b>Option</b>	<b>indicator stand</b>						

Option : Pitframe and Ramp	PLN/pc	Article-Nr
Pitframe KPZ 2, Steel, 600 x 600 mm	On Request	125006060300
Ramp for KPZ 2, steel, 600 mm up to 3t, long 800 mm	On Request	121006060300

Packing dimension	
Type	Dimension
KPZ 2B	130 x 84 x 50 cm, ca 80 kg

Solid and stable platform scales series KPZ 2B. German design and own EU production guarantees high quality. Designed as floor scales, industrial weighing. High accuracy. Maintenance-free durable steel construction. Powder paint coated.

**Construction:** Robust, maintenance-free, welded steel construction, heavy duty design for industrial use, non-slip finish weighing platform, durable black powder coat.

**Load cells:** Robust, nickel-plated load cell, IP68, OIML, with a high overload capacity.

**Installation:** Adjustable leveling feet, designed for permanent or portable installations, 5m cable to connect digital indicator.

**Options:** Extra ramps, Base anchors, Wall mounting for indicator, Indicator stand, Custom sizes and capacities

**Standard indicator:** KPZ 52-18

**For approved applications:** KPZ 52E-8

**Options for indicators:** Multi range, RS 232 serial interface, Various printers connection, Radio data transfer, WLAN, etc.. Internal battery

**Approvals:** OIML class III , CE conform

**Power Supply :** 230 V mains, Power cord

**Special requirements for unique loading - please contact us for more information!**

## Special models are our speciality!

Options / accessories / extra charge	PLN/pc	Article-Nr
<b>Indicators: Options (extra cost)</b>		
Delivery without Indicator KPZ 52E-8, <b>REDUCED PRICE</b>	On Request	1252E8OHNE00
Delivery without Indicator KPZ 52-18, <b>REDUCED PRICE</b>	On Request	125218OHNE00
Indicator KPZ 52E-8 <b>instead of KPZ 52-18</b>	On Request	1252E8000000
Indicator KPZ 52E-8/1, <i>with pre tare and easy counting instead of KPZ 52E-8</i>	On Request	120030000000
Indicator KPZ 52E-8/1, <i>with pre tare and easy counting instead of KPZ 52-18</i>	On Request	12J030000000
Indicator KPZ 56E-3, <i>professional counting, addition, Tare input by hand, instead of KPZ 52E-8</i>	On Request	120324000000
Indicator KPZ 56E-3, <i>professional counting, addition, Tare input by hand, instead of KPZ 52-18</i>	On Request	120324000000
Indicator KPZ 52E-9-1, <i>Stainles steel housing (IP 67) easy counting instead of KPZ 52E-8</i>	On Request	1252E9100000
Indicator KPZ 52E-9-1, <i>Stainles steel housing (IP 67) easy counting instead of KPZ 52-18</i>	On Request	1252J9100000
Indicator KPZ 51E-9-2, <i>Stainles steel housing (IP 67), High/OK/LOW, 10 Memory instead of KPZ 52E-8</i>	On Request	1251E9200000
Indicator KPZ 51E-9-2, <i>Stainles steel housing (IP 67), High/OK/LOW, 10 Memory instead of KPZ 52-18</i>	On Request	1251J9200000
<b>Printers: Options (extra cost) + costs for output RS 232</b>		
Roller printer FAVORIT Plus, for KPZ 51(E)-*,	On Request	120024000000
Printer DR 7	On Request	120039000000
Printer DR 7 with date & time	On Request	120039100000
Label printer and code printer type DR 2 for KPZ 56E-1, KPZ 51E-9-2	On Request	120038000000
Print design for DR 2 on request	On Request	204333100000
<b>serial interface / Setpoints: Options / extra costs</b>		
Serial interface RS232 C for KPZ 52E-8	On Request	1252E8000100
Serial interface RS232 C for KPZ 52-18	On Request	511830700000
Serial interface RS232 C for KPZ 52E-9-1	On Request	123071000000
Serial interface RS232 C for KPZ 51E-9-2	On Request	123072000000
Serial interface RS232 C for KPZ 56E-3 incl. PT and Addition	On Request	123080000000
Serial interface RS232 C for KPZ 56E-3 incl. RTC, w/out PT, w/out Addition	On Request	204300070000
Setpoints, 3 pcs for KPZ 52(E)-8 (more – OK – less)	On Request	120029001000
Setpoints, 3 pcs for KPZ 51E-9-2 (more – OK – less)	On Request	120029002000
Software "KPZ Smart Scale" STANDARD (incl. RS232 serial interface)	On Request	5S0001000000
Software "KPZ Smart Scale" PROFESSIONAL (incl. RS232 serial interface)	On Request	5S0005000000
Software "KPZ Smart Scale" PREMIUM (incl. RS232 serial interface)	On Request	5S0010000000
Wi-Fi Datatransfer	On Request	120005000000
Rechargable battery version KPZ 51(E)-8, 56E-1, 51E-9-1, 51E-9-2	On Request	120040000000
<b>weights &amp; measures certification (extra charge)</b>		
KPZ Factory first certification up to 500 kg	On Request	300PL0000500
KPZ Factory first certification from 550 kg up to 3.000 kg	On Request	300PL0003000
KPZ Factory first certification from 3.050 kg up to 10.000 kg	On Request	300PL0010000
<b>construction accessories (extra charge)</b>		
Indicator stand for KPZ 52(E)-8, KPZ 56E-3	On Request	1S0200000000
Indicator stand for KPZ 52-18,	On Request	1S0220000000
Indicator stand for KPZ 52(E)-9-1, KPZ 51E-9-2	On Request	1S0210000000
Wall mounting indicator KPZ 52(E)-8, KPZ 56E-3	On Request	1S0020000000
Wall mounting indicator KPZ 52-18	On Request	1S0022000000



**KPZ 1-\***

**KPZ 2- \***

**KPZ 2-\***



**KPZ 71-\***

**KPZ 73-\***



**KPZ 72-\***

**KPZ 74-\***



**Weighing forks Forklift truck scale**

**Electronic – Hydraulic version**

**Scale for Coil's**

**Stainless steel, IP 67/68/ 69K**



**KPZ-Waagen Indicator**



**KPZ 52E8**

**KPZ 52E8-1**

**KPZ 56E4**

**KPZ 54-1\***

