

KPZ 2A / Animal scale

Solid Animal scale for hard agricultural use / hot dip galvanized

Capacity : 150/300kg, 600kg and 1500kg, possible



**Standard- Indicator
KPZ 52E-91 IP67**

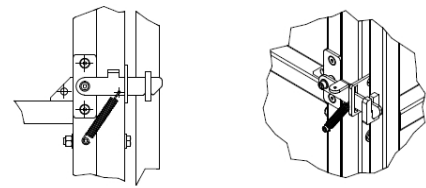

Door lock

**KPZ 2A, 220x92x160cm
1500kg Div. 500g**

Solid and stable animal scale KPZ 2A. **German design and our own EU manufacturing guarantee a high-quality scale.** Platform scale for animals, robust and solid construction, structured plate, metal galvanized protective hurdles. Movable feet with adjustable height, stainless steel. Load cells, IP 68, OIML C3. Certification: EC approval possibility class III, Declaration of Conformity.

Construction: steel, welded frame made of profile with diagonal reinforcement and **galvanized** solid structured plate, flat construction.

Type	Capacity	Division	Indicator	Approval possible	Dim. mm	Article-No.
KPZ 2 EKO	150/300 kg	50/100 g	KPZ 52-18	No	580x1010x1000	2VAA06100300
KPZ 2 EKO	300 kg	100 g	KPZ 52E91/IP67	Yes	580x1010x1000	2VAA0610030E
KPZ 2 EKO	150/300 kg	50/100 g	KPZ 52-18	No	910x1010x1000	2VAA09100300
KPZ 2 EKO	300 kg	100 g	KPZ 52E91/IP67	Yes	910x1010x1000	2VAA0910030E
KPZ 2 EKO	150/300 kg	50/100 g	KPZ 52-18	No	740x1260x1000	2VAA07120300
KPZ 2 EKO	300 kg	100 g	KPZ 52E91/IP67	Yes	740x1260x1000	2VAA0712030E
KPZ 2 EKO	150/300 kg	50/100 g	KPZ 52-18	No	1160x1260x1000	2VAA10120300
KPZ 2 EKO	300 kg	100 g	KPZ 52E91/IP67	Yes	1160x1260x1000	2VAA1012030E
KPZ 2 EKO	150/300 kg	50/100 g	KPZ 52-18	No	510x1510x1000	2VAA05150300
KPZ 2 EKO	300 kg	100 g	KPZ 52E91/IP67	Yes	510x1510x1000	2VAA0515030E
KPZ 2 EKO	150/300 kg	50/100 g	KPZ 52-18	No	670x1510x1000	2VAA06150300
KPZ 2 EKO	300 kg	100 g	KPZ 52E91/IP67	Yes	670x1510x1000	2VAA0615030E
KPZ 2 EKO	150/300 kg	50/100 g	KPZ 52-18	No	660x1810x1000	2VAA07180300
KPZ 2 EKO	300 kg	100 g	KPZ 52E91/IP67	Yes	660x1810x1000	2VAA0718030E
KPZ 2A	1500 kg	500 g	KPZ 52E91/IP67	No	2200x920x1600	2A0009221500
KPZ 2AE	1500 kg	500 g	KPZ 52E91/IP67	YES	2200x920x1600	2A000922150E
KPZ 2A	1500 kg	500 g	KPZ 52E91/IP67	No	2500x920x1600	2A0009221500
KPZ 2AE	1500 kg	500 g	KPZ 52E91/IP67	YES	2500x920x1600	2A000922150E

Weights & measures | hot dip galvanized | good value for money | solid



KPZ 2 A / Platform scale for animals

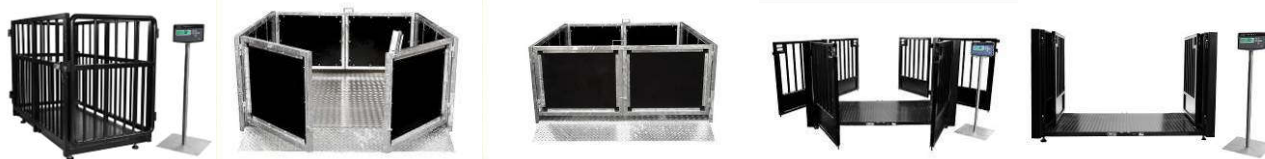

We also offer many types of custom design, depending on customer needs.



KPZ 2 ECO



KPZ 2-11-4

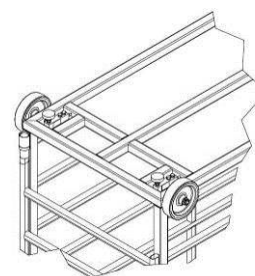
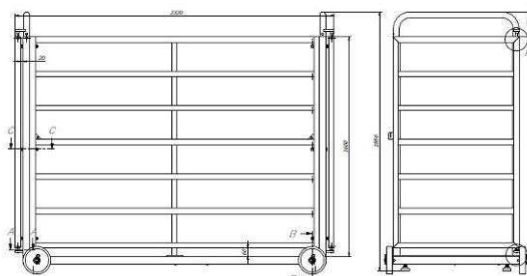

KPZ 2A, low profile Animal platform scale, dim 920 x 2200 mm, robust and stable, high quality steel construction with structured plate, Galvanized version with a galvanized raw framework, Load cells : 4 high quality, OIML approved C 3, DMS load cell, IP 68, type KPZ 502E-3. Weighing Indicator : KPZ 52E91 – sensitive Animal Filter
 Certification : EU type approved version, for retail use, CE - conform.



KPZ 2AA, low profile Animal platform scale, dim 560 x 1510 mm, robust and stable, high quality construction of Aluminum with structured plate, Frame height 850mm, with door at the front and back, and wheels for easy transport Load cells : 4 high quality, OIML approved C 3, DMS load cell, IP 67, type KPZ 502E-3. Weighing Indicator : KPZ 52E91, sensible animal Filter. Certification : EU type approved version, for retail use, CE - conform. Capacity : 0 kg, to 300 kg, Division : 100g



KPZ 2A V



WEIGHING SYSTEM FOR SILO

Special models are our speciality!

German design and own EU production guarantees high quality.

We also offer many types of custom design, depending on customer needs.



Special models are our speciality!

German design and own EU production guarantees high quality.

KPZ 2A / Animal scale

Solid Animal scale for hard agricultural use / hot dip galvanized

Capacity : 150/300kg, 600kg and 1500kg, possible



**Standard- Indicator
KPZ 52E-91 IP67**

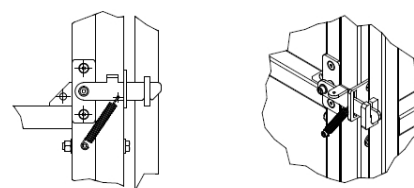

Door lock

**KPZ 2A, 220x92x160cm
1500kg Div. 500g**

Solid and stable animal scale KPZ 2A. **German design and our own EU manufacturing guarantee a high-quality scale.** Platform scale for animals, robust and solid construction, structured plate, metal galvanized protective hurdles. Movable feet with adjustable height, stainless steel. Load cells, IP 68, OIML C3. Certification: EC approval possibility class III, Declaration of Conformity.

Construction: steel, welded frame made of profile with diagonal reinforcement and galvanized solid structured plate, flat construction.

Type	Capacity	Division	Indicator	Approval possible	Dim. mm	Article-No.
KPZ 2 EKO	150/300 kg	50/100 g	KPZ 52-18	No	580x1010x1000	2VAA06100300
KPZ 2 EKO	300 kg	100 g	KPZ 52E91/IP67	Yes	580x1010x1000	2VAA0610030E
KPZ 2 EKO	150/300 kg	50/100 g	KPZ 52-18	No	910x1010x1000	2VAA09100300
KPZ 2 EKO	300 kg	100 g	KPZ 52E91/IP67	Yes	910x1010x1000	2VAA0910030E
KPZ 2 EKO	150/300 kg	50/100 g	KPZ 52-18	No	740x1260x1000	2VAA07120300
KPZ 2 EKO	300 kg	100 g	KPZ 52E91/IP67	Yes	740x1260x1000	2VAA0712030E
KPZ 2 EKO	150/300 kg	50/100 g	KPZ 52-18	No	1160x1260x1000	2VAA10120300
KPZ 2 EKO	300 kg	100 g	KPZ 52E91/IP67	Yes	1160x1260x1000	2VAA1012030E
KPZ 2 EKO	150/300 kg	50/100 g	KPZ 52-18	No	510x1510x1000	2VAA05150300
KPZ 2 EKO	300 kg	100 g	KPZ 52E91/IP67	Yes	510x1510x1000	2VAA0515030E
KPZ 2 EKO	150/300 kg	50/100 g	KPZ 52-18	No	670x1510x1000	2VAA06150300
KPZ 2 EKO	300 kg	100 g	KPZ 52E91/IP67	Yes	670x1510x1000	2VAA0615030E
KPZ 2 EKO	150/300 kg	50/100 g	KPZ 52-18	No	660x1810x1000	2VAA07180300
KPZ 2 EKO	300 kg	100 g	KPZ 52E91/IP67	Yes	660x1810x1000	2VAA0718030E
KPZ 2A	1500 kg	500 g	KPZ 52E91/IP67	No	2200x920x1600	2A0009221500
KPZ 2AE	1500 kg	500 g	KPZ 52E91/IP67	YES	2200x920x1600	2A000922150E
KPZ 2A	1500 kg	500 g	KPZ 52E91/IP67	No	2500x920x1600	2A0009221500
KPZ 2AE	1500 kg	500 g	KPZ 52E91/IP67	YES	2500x920x1600	2A000922150E

Weights & measures | hot dip galvanized | good value for money | solid





KPZ 2AV / Animal scale  
Solid Animal scale for hard agricultural use
Better quality: We use only EU approved components !!!

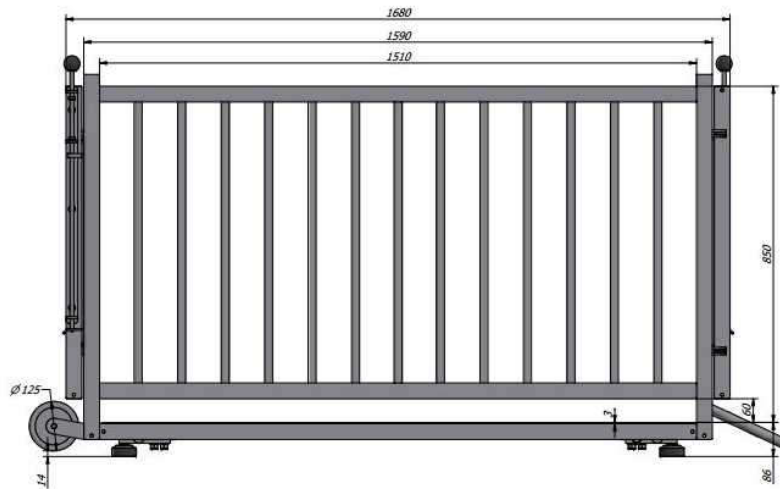
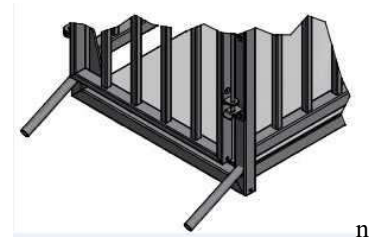

Standard- Indicator KPZ 52E-91



KPZ 2AV, 1510x560x850, 300 kg, division 100g, hot dip galvanized

Typ	Kapazität	Teilung	Abmessungen mm	Eichung möglich	Anzeige	Art.-Nr.
KPZ 2AV	300 kg	100 g	1510x 560x850	No	KPZ 52E91/IP67	2A0005150300
KPZ 2AVE	300 kg	100 g	1510x 560x850	yes  	KPZ 52E91/IP67	2A000515030E

KPZ 2AV animal weighing machine, dim. 560 x 1510 x 850 mm, extremely solid and stable steel construction, structured aluminum platform surface. Construction hot dip galvanized, grid height 850mm with water proof screen plate, with front and rear doors, castors for comfortable transport. Load cell: high-quality, KPZ 502E-3 compliant strain gauge cells, IP 68, OIML C3.

Approvals: EU Class III, CE compliant, legible or non-compliant version available.

Connection: High-quality shielded connection cable m, protected underneath the platform.

Installation: ball base, height-adjustable, floor position, leveling table for leveling platform.

Standard electronic indicator: KPZ 52E91/IP67, with extremely optimized animal filter function

... do not hesitate to contact us !

KPZ 2AA / Animal scale

Solid Animal scale for hard agricultural use

Very light aluminum construction



Solid and stable scales series KPZ 2AA+2AN. German design and own EU production guarantees high quality. Designed as floor scales, for agricultural weighing. High accuracy. Maintenance-free high quality construction of Aluminum or Stainless Steel.

KPZ 2AA+2AN, low profile **ALUMIN**construction Animal platform scale, dim 560 x 1510 mm, robust and stable, high quality construction of Aluminum with structured plate, Frame height 850mm, with door at the front and back, and wheels for easy transport
 Load cells : 4 high quality, OIML approved C 3, DMS load cell, IP 67/68, type KPZ 502E-3.
Weighing Indicator : KPZ 52E91/IP67, sensible animal Filter. Certification : EU type approved version, for retail use, CE - conform.
 Capacity : 0 kg, to 300 kg, Division : 100g

Aluminium Construction

Typ	Capacity	Div.	Dim. mm	Approval possibility	Indicator	Art.-No.
KPZ 2AA	300 kg	100 g	1470x 470x850	No	KPZ 52E91/IP67	2AA004140300
KPZ 2AAE	300 kg	100 g	1470x 470x850	yes	KPZ 52E91/IP67	2AA00414030E
KPZ 2AA	300 kg	100 g	1510x 560x850	No	KPZ 52E91/IP67	2AA005150300
KPZ 2AAE	300 kg	100 g	1510x 560x850	yes	KPZ 52E91/IP67	2AA00515030E

Stainless Steel Construction

Typ	Capacity	Div.	Dim. mm	Approval possibility	Indicator	€/pcs.	Art.-No.
KPZ 2AN	300 kg	100 g	1510x 560x850	No	KPZ 52E91/IP67		2AN005150300
KPZ 2ANE	300 kg	100 g	1510x 560x850	yes	KPZ 52E91/IP67		2AN00515030E

Other dimensions, capacities and options on request.

German design and own EU production guarantees high quality.

Weights & measures | hot dip galvanized | good value for money | solid



KPZ 2ECO / Animal scale



Better quality: We use only EU approved components !!!
 The German Construction and own EU production guarantees high quality.



Standard- Indicator
 KPZ 52E-91 IP67



KPZ 2A, 220x92cm, 1500kg Div. 500g

Typ	Capazität	Division	Dim. mm	Approval possible	Indicator	Art.-No.
KPZ 2A	1000 kg	500 g	2200x920mm	No	KPZ 52E91/IP67	2AOH09221500
KPZ 2AE	1000 kg	500 g	2200x920mm	YES  	KPZ 52E91/IP67	2AOH0922150E
Options / accessories / extra charge						Article-Nr
Side Bars						

Solid and stable animal scale KPZ 2A series. **German design and our own EU manufacturing guarantee a high-quality scale.** Version as floor scales, for animal weighing. Usable for legal and non-legal applications. High precision. Maintenance-free, Fire galvanized steel construction.

Platform scale for animals KPZ 2A, very robust and solid construction, galvanized structured plate, metal galvanized. Movable feet with adjustable height, stainless steel.

Load cells: High quality load cells DMS type KPZ 502E-3, IP 68, OIML C3. **Indicator:** KPZ 52E-9-1 **Certification:** EC approval possibility class III, Declaration of Conformity.

Construction: steel, welded frame made of profile with diagonal reinforcement and solid structured plate, **galvanized** (option: black powder painted or stainless steel construction). Indicator connection cable: length 5 m, sheltered at way out of scale in case of mechanical damage. Special flat construction is suitable for ground placing. With regard to solid DMS load cells there are no wearing out parts.



Description: solid stainless steel housing IP 67, user-friendly, large function keys. LCD display: 6 digit, various symbols, backlight. Operating temperature from -10°C up to +40°C.
Power supply: 230 V, battery version (option). **Functions:** automatic and manual zero setting, switch Net/Gross weight, 100% tare, multiple tare, unit switching, simple piece counting by reference no. 10, 20, 50, 100 i 200. Minus indication, LCD backlight, automatic shut off after 0-9 minutes, pre-set value control or limit value control LOW – OK - HIGH (any two weight values to choose, tone or light signal), electronic stabilization filter, automatic selftest, error messages.
Indication: zero setting, gross, net, stability, LOW-Bat indication, pre-set/limit value, too small piece quantity or too small weight. **LED:** charging status.

Other dimensions, capacities and options on request.

German design and own EU production guarantees high quality.



KPZ 2S ECO / Platform scale

Solid floor scales up to 800 kg for Standard use

Option : A grid frame with a height of 1000mm can be offered for each KPZ 2 ECO dimension.

Weights & measures | hot dip galvanized Frame | Alumin Top plate | solid



laundry scale
on Request



Solid and stable platform scales KPZ 2ECO. **German design and own EU production guarantees high quality.** Designed as floor scales, industrial weighing. High accuracy. Maintenance-free durable steel construction. Powder paint coated.

Construction: Robust, maintenance-free, welded steel construction, heavy duty design for industrial use, non-slip finish Aluminw eighing platform, durable black powder coat. **Load cells:** Robust, nickel-plated load cell, IP68, OIML, with a high overload capacity. **Levelling feet.** **Installation:** Adjustable leveling feet, designed for permanent or portable installations, 5m cable to connect digital indicator. **Options:** Extra ramps, Base anchors, Wall mounting for indicator, Indicator stand, Custom sizes and capacities

Standard indicator: KPZ 52-18, **For approved applications:** KPZ 52E-8, **Options for indicators:** Multi range, RS 232 serial interface, Various printers connection, Radio data transfer, WLAN, etc.. Internal battery. **Power Supply :** 230 V mains, Power cord. **Approvals:** OIML class III , CE conform.

Type	Capacity	Division	Indicator	Approval possible	Dim. mm	Article-No.
KPZ 2 EKO	150/300 kg	50/100 g	KPZ 52-18	No	580x1010x85	2VA006100300
KPZ 2 EKO	300 kg	100 g	KPZ 52E-8	Yes	580x1010x85	2VA00610030E
KPZ 2 EKO	150/300 kg	50/100 g	KPZ 52-18	No	910x1010x85	2VA009100300
KPZ 2 EKO	300 kg	100 g	KPZ 52E-8	Yes	910x1010x85	2VA00910030E
KPZ 2 EKO	150/300 kg	50/100 g	KPZ 52-18	No	740x1260x85	2VA007120300
KPZ 2 EKO	300 kg	100 g	KPZ 52E-8	Yes	740x1260x85	2VA00712030E
KPZ 2 EKO	150/300 kg	50/100 g	KPZ 52-18	No	1160x1260x85	2VA010120300
KPZ 2 EKO	300 kg	100 g	KPZ 52E-8	Yes	1160x1260x85	2VA01012030E
KPZ 2 EKO	150/300 kg	50/100 g	KPZ 52-18	No	510x1510x85	2VA005150300
KPZ 2 EKO	300 kg	100 g	KPZ 52E-8	Yes	510x1510x85	2VA00515030E
KPZ 2 EKO	150/300 kg	50/100 g	KPZ 52-18	No	670x1510x85	2VA006150300
KPZ 2 EKO	300 kg	100 g	KPZ 52E-8	Yes	670x1510x85	2VA00615030E
KPZ 2 EKO	150/300 kg	50/100 g	KPZ 52-18	No	660x1810x85	2VA007180300
KPZ 2 EKO	300 kg	100 g	KPZ 52E-8	Yes	660x1810x85	2VA00718030E
KPZ 2A	1500 kg	500 g	KPZ 52E91/IP67	No	2200x920mm	2AOH09221500
KPZ 2AE	1500 kg	500 g	KPZ 52E91/IP67	Yes	2200x920mm	2AOH0922150E

... please contact us for special requests!

. German design and own EU production guarantees high quality.

Weights & measures | hot dip galvanized | good value for money | solid

Special models are our speciality!



KPZ 1BSX | Beam scale

Solid Pallet scale for industrial use | Capacity : up to 2.000kg



Inexpensive version



Fixing Clamps for fixed attachment to the beam. Available in a set of 4 or 6 pieces.

Type	Capacity	Division	Indicator	Dim. mm	Approval	Art-Nr.
KPZ 1BSXM	1500 kg	500 g	KPZ 52E-8	85 x 600	Yes	1BSXM0061500
KPZ 1BSXM	1000/2000 kg	500/1000 g	KPZ 52-18	85 x 600	No	1BSXM0061500
KPZ 1BSXM	2000 kg	1000 g	KPZ 52E-8	85 x 600	Yes	1BSXM0062000
KPZ 1BSXM	1000/2000 kg	500/1000 g	KPZ 52-18	85 x 600	No	1BSXM0062000
KPZ 1BSXM	1000/2000 kg	500/1000 g	without	85 x 1000	Yes	1BSXM00102000
KPZ 1BSXM	1000/2000 kg	500/1000 g	without	85 x 1200	Yes	1BSXM00122000
KPZ 1BSXM	1000/2000 kg	500/1000 g	without	85 x 1500	Yes	1BSXM00152000
KPZ 1BSXM	1000/2000 kg	500/1000 g	KPZ 52-18	85 x 1000	No	1BSXM0102000
KPZ 1BSXE	1500 kg	500 g	KPZ 52E-8	85 x 1000	Yes	1BSXE0010150E
KPZ 1BSX	1500 kg	500 g	KPZ 52-18	85 x 1000	No	1BSX00101500
KPZ 1BSXE	2000 kg	1000 g	KPZ 52E-8	85 x 1000	Yes	1BSXE0010200E
KPZ 1BSX	2000 kg	1000 g	KPZ 52-18	85 x 1000	No	1BSX00102000
KPZ 1BSXM	1000/2000 kg	500/1000 g	KPZ 52-18	85 x 1200	No	1BSXM0122000
KPZ 1BSXE	1500 kg	500 g	KPZ 52E-8	85 x 1200	Yes	1BSXE0012150E
KPZ 1BSX	1500 kg	500 g	KPZ 52-18	85 x 1200	No	1BSX00121500
KPZ 1BSXE	2000 kg	1000 g	KPZ 52E-8	85 x 1200	Yes	1BSXE0012200E
KPZ 1BSX	2000 kg	1000 g	KPZ 52-18	85 x 1200	No	1BSX00122000
KPZ 1BSXM	1000/2000 kg	500/1000 g	KPZ 52-18	85 x 1500	No	1BSXM0152000
KPZ 1BSXE	1500 kg	500 g	KPZ 52E-8	85 x 1500	Yes	1BSXE0015150E
KPZ 1BSX	1500 kg	500 g	KPZ 52-18	85 x 1500	No	1BSX00151500
KPZ 1BSXE	2000 kg	1000 g	KPZ 52E-8	85 x 1500	Yes	1BSXE0015200E
KPZ 1BSX	2000 kg	1000 g	KPZ 52-18	85 x 1500	No	1BSX00152000

Fixing clamps for KPZ 1B for 85mm profile, 4 pieces	1B000000100
Fixing clamps for KPZ 1B for 85mm profile, 6 pieces	1B000000200

Solid and stable scales series KPZ 1BSX. **German design and own EU production guarantees high quality.** **Designed** as floor scales, industrial weighing. High accuracy. Maintenance-free durable steel construction. Powder paint coated.

Construction: Robust, maintenance-free, welded steel construction, heavy duty design for industrial use, durable black powder coat. **Load cells:** Robust, nickel-plated load cell, IP68, OIML, with a high overload capacity.

Levelling feet. Installation: Adjustable leveling feet, designed for permanent or portable installations, 5m cable to connect digital indicator. **Options:** Base anchors, Wall mounting for indicator, Indicator stand, Custom sizes and capacities

Standard indicator: KPZ 52-18, **For approved applications:** KPZ 52E-8, **Options for indicators:** Multi range, RS 232 serial interface, Various printers connection, Radio data transfer, WLAN, etc.. Internal battery.

Approvals: OIML class III , CE conform. **Power Supply** : 230 V mains, Power cord

Special requirements for unique loading / please contact us for more information!



WEIGHING SYSTEM FOR SILO



KPZ 51E-41 indicator



X

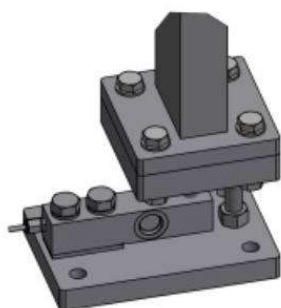

Weighing module – technical data

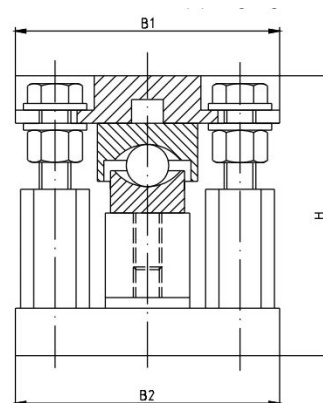
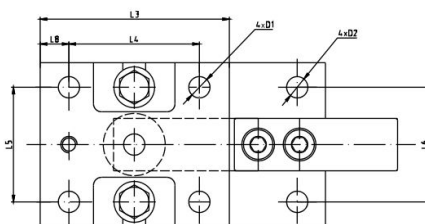
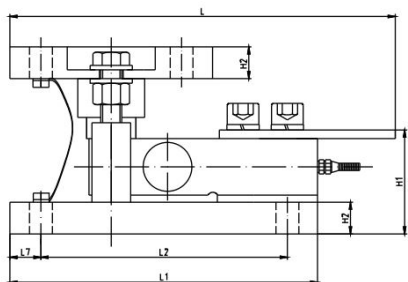

capacity	H	H1	H2	B1	B2	D1	D2	L	L1	L2	L3	L4	L5	L6	L7	L8
0,1-2,5t	106	58	18	100	100	Ø13	Ø13	210	175	140	1167	80	70	70	17,5	18
3-5t	135	69,1	23	150	150	Ø17	Ø17	270	235	200	150	100	90	90	15	25
7,5-10t	186,3	91,3	38	180	180	Ø26	Ø26	345,2	310	250	210,4	150,4	110	110	30	30

0.1~5t

Weighing module installation

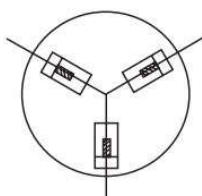

Radial mounting

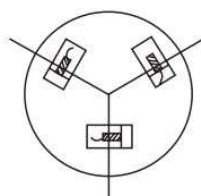

Cutting mounting

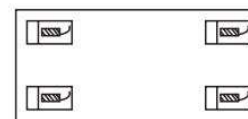

Rectang mounting

Component		Article-Nr.
Indicator KPZ 51E-41		ZM51E4100000
Junction box 4 load cells		ZM08080000000
Junction box 6 load cells		ZM0808000006
Mounting kit up to 2500kg		WM052E302500
Mounting kit up to 5000kg		WM052E305000
Mounting kit up to 10000kg		WM052E310000

German design and own EU production guarantees high quality.

Available load cells capacities: 250kg, 500kg, 1000kg, 1500kg, 2000kg, 2500kg, 3000kg, 5000kg, 7500kg, 10000kg.

KPZ 51E-41 indicator

<p><u>Characteristics:</u> Software: Base</p> <ul style="list-style-type: none"> - Zeroing - Tare - Hand tare - Gross / Net switching - simple piece counting - Add function - automatic zeroing function <p><u>Function (Optional):</u></p> <ul style="list-style-type: none"> - Print function including date and time, external button - I / O inputs as net / gross switching, zeroing, peak value, printout - I / O outputs as set point function - Communication protocol via serial interface - 5 set points (4 set points if analogue output is available) Configurable as open or normally closed. The set points can be set as net weight, gross weight, for positive or for positive and negative weights. - Setting the hysteresis value for each set point. 	<p><u>Option (extra charge):</u></p> <ul style="list-style-type: none"> - Wall mounting - Stand - Battery - Alibi memory - Analog output - I/O's, relay output - Printer - Serial interface RS232 and RS485 - Remote display - Profibus, Ethernet TCP/IP, Modbus, CANopen, DeviceNet. <p><u>Power supply:</u></p> <ul style="list-style-type: none"> - Mains 110-240VAC, 3m long cable <p><u>Technical Data:</u></p> <ul style="list-style-type: none"> -LCD display, backlit (6 digit 20mm high, semi alphanumeric) - 16 icon displays - Robust ABS housing IP67 - Temperature range: -10 ° C to 40 ° C - dim. 122x226x164mm - EU type approval Class III to 10,000e
--	---

KPZ 502E-3, Scherstab-Wägezelle, legierter Stahl, IP68, C3
Shear beam load cell, alloy steel, IP68, C3
Tenzometrický snímač hmotnosti alloy steel, IP68, C3
Kapazität/Capacity/ Váživost : 250kg - 5000kg

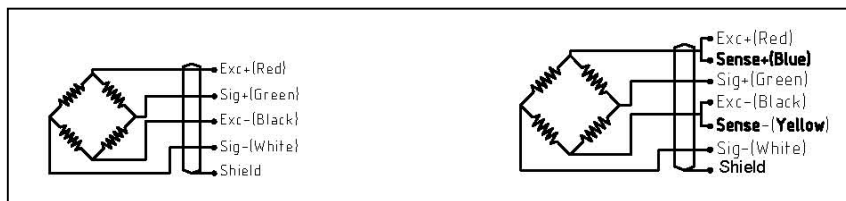
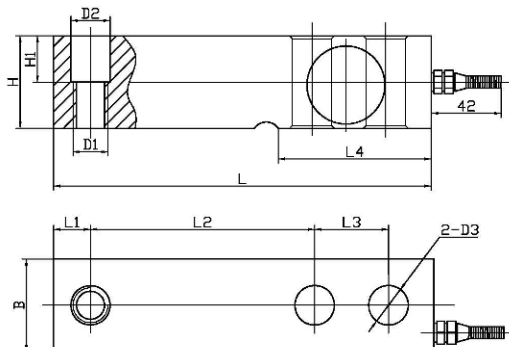

Abmessungen / dimensions:

Kapazität / capacity		L	H	B	L1	L2	L3	L4	D3	H1	D2	D1
250 – 2.500kg	mm	130,0	31,8	31,8	12,7	76,2	25,4	53,5	13,0	20,0	13,5	M 12 x 1,50
3.000 - 5000kg	mm	171,5	38,1	38,1	19,0	95,3	38,1	72,5	20,0	26	20,0	M 18 x 1,50

Technische Daten / specification:

Emax	t	0,25	0,5	1	1,5	2	2,5	3	5
Vmin	kg	0.02	0.05	0.1	0.15	0.2	0.25	0.3	0.5
Emin	kg	0							
Dmin	kg	0							
Humidity Class		CH							
Accuracy class		C3							
Zero balance	%F.S	±1							
Rated output	mV/V	3.0±0.0.003							
Y parameter		10000							
Z parameter		3000							
Resistance Input	Ω	400±10							
Output	Ω	352±3							
Insulation	MΩ	≥5000							
Safe load limit	%F.S	150							
Lateral load limit	%F.S	180							
Recommend excitaion	V.DC	10							
Maximum excitaion	V.DC	15							
Protection class		IP68							
Construction		Alloy steel							
Operating Temp Range	°C	-10~40							
Cable length	m	As per customers' requirements							

KPZ 502E-3, Scherstab-Wägezelle, legierter Stahl, IP68, C3
Shear beam load cell, alloy steel, IP68, C3
Tenzometrický snímač hmotnosti alloy steel, IP68, C3
Kapazität/Capacity/ Váživost : 7,5t – 10t

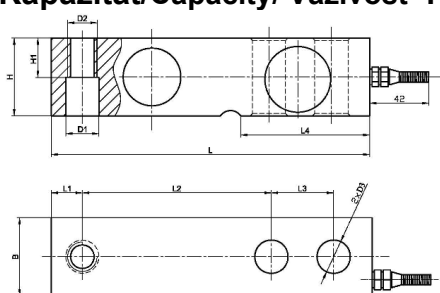



Abmessungen / dimensions:

Kapazität / capacity		L	H	B	L1	L2	L3	L4	D3	H1	D1	D2
7,5t – 10t	mm	225,5	50,8	50,8	25,3	124,0	50,8	102	27,0	25,4	27,0	M 24 x 2,0

Technische Daten / specification:

Emax	t	7.5	10
Vmin	kg	0.75	1.0
Emin	kg		0
Dmin	kg		100
Humidity Classification			CH
Accuracy class			C3
Zero balance	%F.S		±1
Rated output	mV/V		3.0±0.03
Y parameter			10000
Z parameter			3000
Resistance Input	Ω		400±20
Output	Ω		352±3
Insulation	MΩ		≥5000
Safe load limit	%F.S		150
Lateral load limit	%F.S		200
Recommend excitaion	V.DC		10
Maximum excitaion	V.DC		15
Protection class			IP68
Construction			Alloy Steel
Operating Temp Range	°C		-10~40
Cable length	m	As per customers' requirements	

KPZ 599-5, Bearing Foot for KPZ 502E-3 Shear Beam
 KPZ 599-5 Stabiler Fuß zur KPZ 502E-3 Scherstab-Wägezelle
 Stabilní nožička k KPZ 502E-3 shearbeam-snímač
 Selfleveling, chrome plated with adjustable thread M12 or M18
 Selbst nevlilierend mit Kugel, verchromt, mit Gewinde M 12 oder M18
 Samonastavovací s kuličkovým ložiskem, chromovaná se závitem M 12 nebo M 18

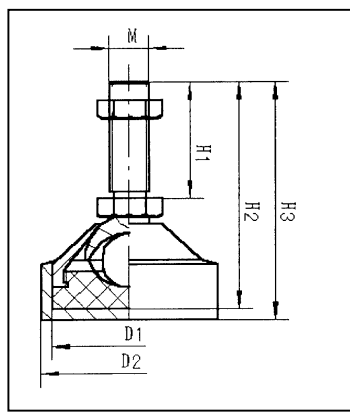
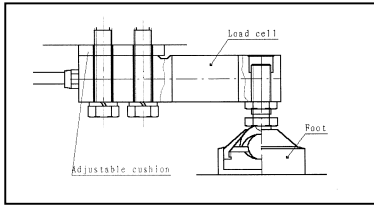

Technical data							
Capacity	Art. number	D1	D2	H1	H2	H3	M
250 – 2.500kg	01052E302500	Ø54 mm	Ø62 mm	45 mm	85 mm	85 mm	M 12 x 1,75 mm
3.000 - 5000kg	01052E305000	Ø54 mm	Ø62 mm	60 mm	105 mm	110 mm	M 18 x 1,50 mm

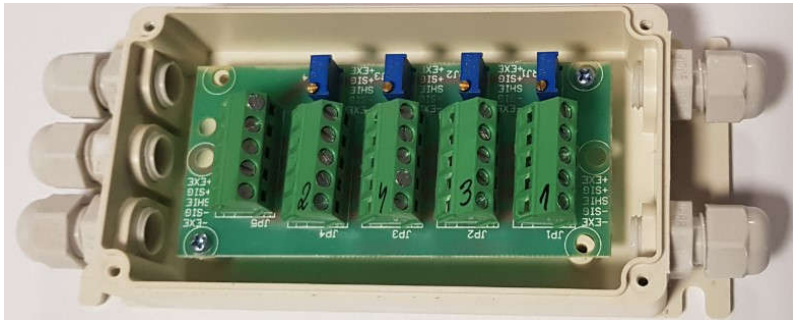

Z0909000000

Slučovací skříňka KPZ Z09-9, pro 4 tenzometry v robustním ABS pouzdře , s potentiometrem
 KPZ Z09-9, junction box, board with potentiometer, for up to 4 load cells, in ABS housing, with cable glands:
 Sammeldose KPZ 09-9, für 4 Wägezellen, im robustem Plasticgehäuse, mit Potentiometer.

KPZ 502E-3 Scherstab Wägezelle, Werkzeugstahl vernickelt, IP 68, Kap. 1000kg, Gewinde M12/M18, eichfähig C3
 KPZ 502E-3 share beam load cell, nickel plated steel, IP 68, Cap. 1000kg, approved C3, M12/M18 thread
 KPZ 502E-3 tenzometrický snímač, nástrojová ocel, pozinkovaný, IP 68, s polovičním dírovým závitem M 12/M18, cejchuschopný C 3,

Typ	Capacity/kg		Approval	Article No.
KPZ 502E3	250	alloy steel	YES/Ano/JA	W052E3000250
KPZ 502E3	500	alloy steel	YES/Ano/JA	W052E3000500
KPZ 502E3	1.000	alloy steel	YES/Ano/JA	W052E3001000
KPZ 502E3	1.500	alloy steel	YES/Ano/JA	W052E3001500
KPZ 502E3	2.000	alloy steel	YES/Ano/JA	W052E3002000
KPZ 502E3	2.500	alloy steel	YES/Ano/JA	W052E3002500
KPZ 502E3	3.000	alloy steel	YES/Ano/JA	W052E3003000
KPZ 502E3	5.000	alloy steel	YES/Ano/JA	W052E3005000
KPZ 502E3	7.500	alloy steel	YES/Ano/JA	W052E3007500
KPZ 502E3	10.000	alloy steel	YES/Ano/JA	W052E3010000
KPZ 502E3N	250	Stainless	YES/Ano/JA	WN052E3000250
KPZ 502E3N	500	Stainless	YES/Ano/JA	WN052E3000500
KPZ 502E3N	1.000	Stainless	YES/Ano/JA	WN052E301000
KPZ 502E3N	1.500	Stainless	YES/Ano/JA	WN052E301500
KPZ 502E3N	2.000	Stainless	YES/Ano/JA	WN052E002000
KPZ 502E3N	2.500	Stainless	YES/Ano/JA	WN052E002000
KPZ 502E3N	3.000	Stainless	YES/Ano/JA	WN052E003000
KPZ 502E3N	5.000	Stainless	YES/Ano/JA	WN052E005000
Feet	Fuß			
KPZ 599-5	250 – 2.500	Feet		010530023000
KPZ 599-5	3.000 - 5000	Feet		010530024000
KPZ 599-5	7.500 - 10000	Feet		010530025000
Junctionbox	Sammeldose			
KPZ Z09-9,				Z09090000000

Indicator Type	Article-Nr
Indicator KPZ 52E-8	Z52E8000000
Indicator KPZ 52E-8/1, with pre tare and easy counting	Z52E81000000
Indicator KPZ 56E-3, professional counting, addition, Tare input by hand	Z56E30000000
Indicator KPZ 56E-4, professional counting, addition, Tare input by hand, (frontpanel version)	Z56E40000000
Indicator KPZ 52-18	Z52180000000
Indicator KPZ 52-19 (forntpanel version)	Z52190000000
Indicator KPZ 52-7-2 (frontpanel version)	Z52720000000
Indicator KPZ 52E-9-1, Stainles steel housing (IP 67) easy counting	Z52E91000000
Indicator KPZ 51E-9-2, Stainles steel housing (IP 67), High/OK/LOW, 10 Memory	Z51E92000000

KPZ Indicators

 <p>KPZ 52E-7</p> <p>Klasse III M</p>	 <p>KPZ 52E-7/1</p> <p>Klasse III M</p>	 <p>KPZ 56E-4</p> <p>Klasse III M</p>
 <p>KPZ 52E-9-1</p> <p>Klasse III M</p>	 <p>KPZ 51E-9-2</p> <p>Klasse III M</p>	 <p>KPZ 51E11 - 13</p>
 <p>KPZ 58-2</p> <p>Klasse III M</p>	 <p>KPZ 52-19</p>	 <p>Big display/second display</p>
 <p>KPZ 54E-*</p> <p>Klasse III M</p>	 <p>KPZ 54E-*</p> <p>Klasse III M</p>	

KPZ Indikátory

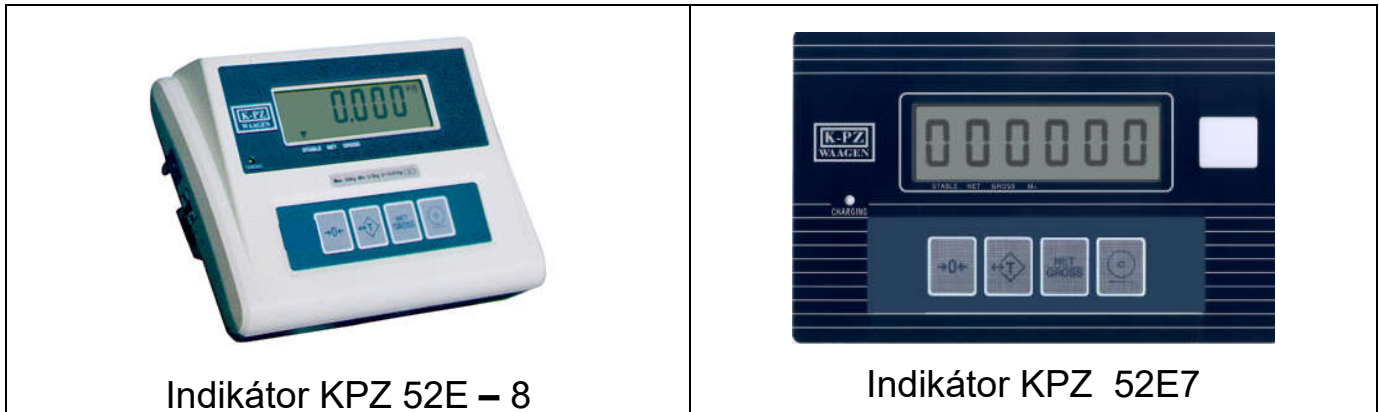

Klasse
III **M**

Multirange division : See technical data of the scale. OIML Class



Description KPZ 52(E) - 7

Robust external case made from ABS incorporating a water-proof front keypad with large function keys. 6- digit, 26 mm high LCD – Display with back-light function providing a clear and easily readable weight indication. Operating temperature – 10 to + 40 °C. 230 Volt-operation.

Function : automatic and manual Zero setting. Tare setting up to 100 %, switch Net and gross weight repeatedly. Optional RS 232 Data output and addition sum printing, minus indication, LCD back-light (3 settings), audible/visible alarm/check HIGH-OK-LOW (That means two available value of weight), automatic selftest, Error message on display.

LED indication for : Zero, Tare weight, stabile, LOW Bat, power, addition memory.





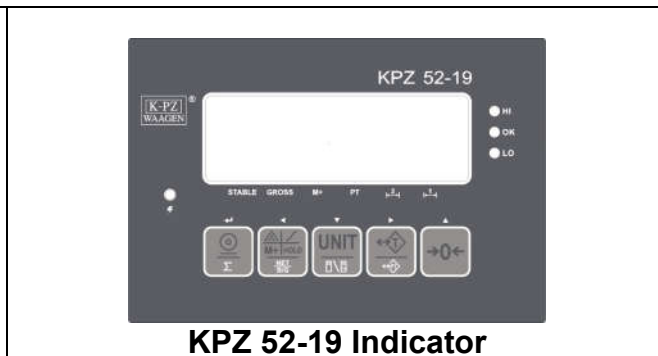

Options: Configurable RS 232 output, data output (different formats), Roller printer, label printer, set point (High-OK-Low),

Key	Description
ON/OFF	This key is installed on the ABS housing. This key is used to switch the indicator ON or OFF. When activated the display shows the $\rightarrow 0 \leftarrow$ signal is on.
$\rightarrow 0 \leftarrow$	If the LCD Display is not indicating 0.00 , press this key to re-zero the scale. The display indicates that the ZERO signal is now on. The unit can zero $\pm 2\%$ of the max. capacity. Using this switch do not change the range of maximal capacity.
$\leftrightarrow T$	This key is used to carry out tare and zero settings, when an existing weight is on the scale. If a TARE weight is stored, the Tare Signal will indicate over Net . As soon as you remove the TARE weight re-set to ZERO by the user of the scale, the display shows the weight with a minus symbol in front on the LCD display. The maximum weighing range is reduced for the tare value. Tare capability is 100% of the scale capacity, and can be used repeatedly. Multiple tare is possible. Negative weight values can be moved to 0.00 .
<u>NET</u> GROSS	This key is used to switch between net and gross weight repeatedly. The display indicate Net or τ GROSS. This $\frac{NET}{GROSS}$ key can be used only when the scale is in the tare mode. By showing the Gross value (τ GROSS) the other keys are closed.
	If a printer interface is installed, this key will print out (printer version) or transfer the weight data being displayed . The weight value is stored in the data logger. The display indicate τ M+ .To print the grand total of all printed weights the weight must be removed. The display shows $\rightarrow 0 \leftarrow$. Then press the  key twice the total sum of the weighing results will be printed .

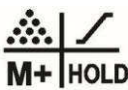
KPZ Indicators



Robust external case including a water-proof front keypad with large function keys. 6-digit, 30 mm high LCD – Display with blue back-light function providing a clear and easily readable weight indication. Operating temperature – 10 to + 40 °C. 230 Volt-operation. Battery operation possible. **Function** : automatic and manual Zero setting. Tare setting up to 100 %, pretare function, switch Net and gross weight repeatedly. Optional RS 232 Data output and addition sum printing, minus indication, HIGH-OK-LOW function, totalizing function, automatic selftest, Error message on display. **LED indication for** : Zero, Tare weight, stable, LOW Bat, HI LOW OK .
Options: RS 232 output, data output, Roller printer,

Key	Function	Hold for 1 sec.
	Printout / data output (Option)	Communication settings
Σ	Totalizing	
	Modus selection / Function	
	Switching between net and gross weight (net mode)	
UNIT	switching units	
	Switch between weight / unit weight (piece counting mode)	
	Tare	1. Backlight 2. Switch on zero setting 3. Gravitation value
	Pretare	
	Zero	battery voltage

KPZ Indicators

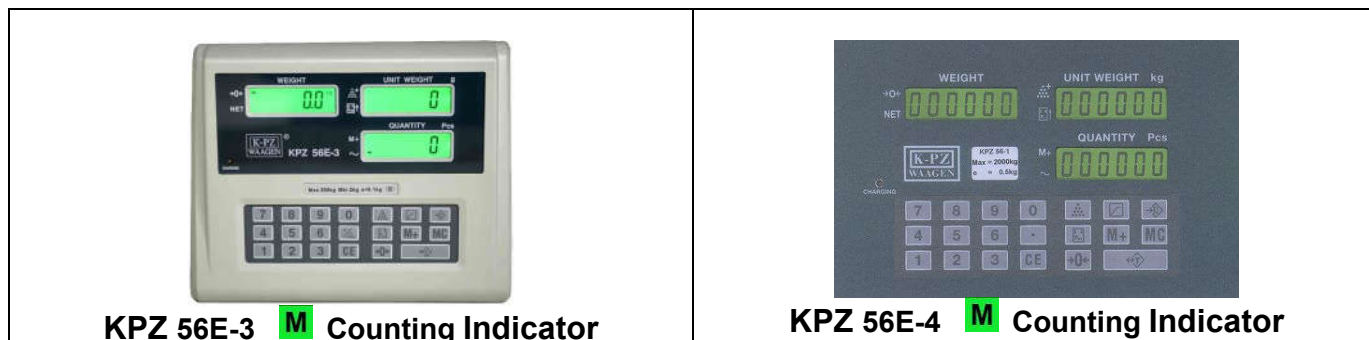

Optimal unit weight for the piece count: 1/5 of the scale division.

This high-quality Parts Counting Indicator can be used in all types of uncertified and for trade weighing applications. Due to the high external resolution and the 20x expanded internal resolution, the unit is ideally suitable for both small and large item component counting. The expanded internal resolution of the indicator provides clear signal stability and repeatability. The 3 window highly visible LCD-Display provides the operator with clear data information. Additionally, with the robust construction of a steel housing, built-in rechargeable battery, and the simple to operate dust and waterproof front keypad, makes this part counting indicator a valuable tool for all industrial weighing & counting applications.

Description of Keypad

0 to 9 and .	Use to enter piece weight, total quantity or Tare value.
CE:	Deletes all value entered via the keypad.
→0←	1) Use this key to Zero the scale 2) Use this key by pressing twice to enter backlight options (see Backlight Function)
→T←	Use this key to Tare the scale
→P←	Use this key to confirm entered quantity.
→W←	Use this key to confirm entered piece weight.
→L←	Use this key to pre-set upper count limit, when the value is achieved an audible signal will be emitted.
→M←	Use this key to save a piece weight in memory.
M+	Count accumulation key.
MC	Deletes all accumulation count in memory.

Standard features :Indicator: Display indication 1/30.000, internal divisions 1/600.000. Built-in calibration routine. Automatic & manual zero setting. 100% Tare. Piece Counting. The tare value and the piece weight can be weighed or entered via the front keyboard. The indicator has a 10 piece weight memory. 3 window LCD display with back-lighting option showing weight, quantity and individual piece weight. Counting accumulation. Audible peak alarm for Multi counting applications. Symbol indication shown at display for : Power re-charging control, LO-BAT. Zero, Tare, Stable, Memory, Piece number, Piece weight.

Options :

Factory configured serial interface (RS 232). With this interface in addition to date, weight & count information, two additional 15 character line entries can be included (for example Item number, operator number etc.) Printing from this interface via a single tally roll printer or label printer which will print all data in a numerical format, or in a range of standard **Barcodes**.

KPZ Indicators

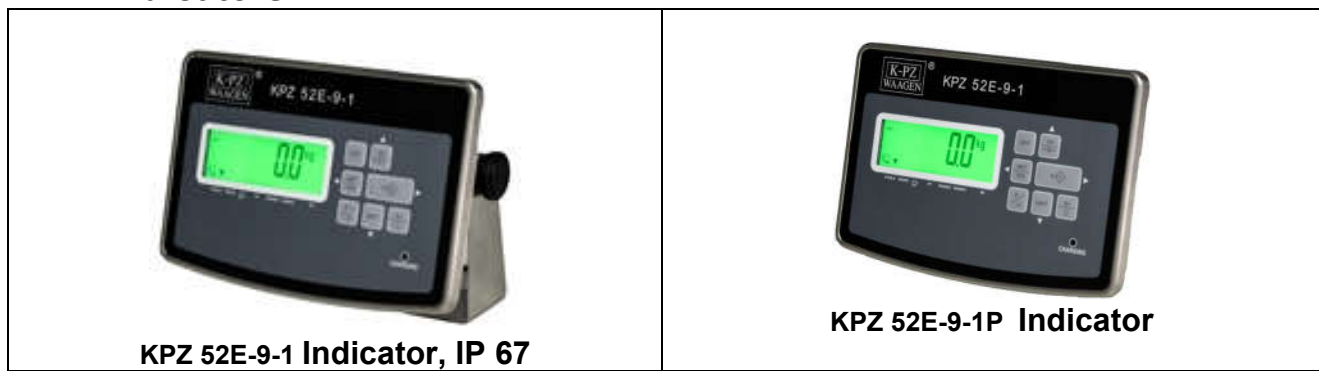

OIML trade approved Class III **M**, 10.000 e

Technical data: Indicator: **KPZ 52E-9-1** robust, stainless steel housing **IP 67**, user-friendly, large function keys. LCD display: 6 digit, various symbols, backlight, high of digits 25 mm. Operating temperature from -10°C up to +40°C, operation 230 Volt through external power supply, inbuilt battery (possibility of battery operation).

Functions: automatic and manual zero setting, switch Net/Gross weight, 100% tare, multiple tare, unit switching, simple piece counting by reference no. 10, 20, 50, 100 i 200. Possibility to enter data and bring out data through serial interface (optional): computer functional control, possibility of choosing different exit formats, **printout in simple format**, edition activation: via computer, continuously or after zero come back. Minus indication, LCD backlight, automatic shut off after 0-9 minutes, pre-set value control or limit value control LOW – OK - HIGH (any two weight values to choose, tone or light signal), electronic stabilization filter and signal distortion, automatic self test, error messages.

Indication: zero setting, gross, net, stability, LOW-Bat indication, pre-set/limit value, too small piece quantity or too small weight. **LED:** charging status. **Options:** serial interface RS 232, battery, label printer

Key functions:

Key	Description
ON	<i>switch the indicator ON</i>
→0←	<i>Switch the indicating to 0.00</i>
OFF	<i>switch the indicator OFF</i>
↔T	<i>TARE function</i>
NET GROSS	<i>Switch over Net / Gross Tare, repeatedly</i>
UNITS	<i>Switch over weighing units</i>
F/HR	<i>In approval version: High resolution indication (5 sec)</i>
M+	<i>Totalizing and printout/ data output</i>

Robust external case including a water-proof front keypad with large function keys. 6-digit, 30 mm high LCD – Display with blue back-light function providing a clear and easily readable weight indication. Operating

KPZ 54-* / Touch screen indicator



- Touch Operating System for user friendly and fastest operations.
- Multi-printer selectable
- Custom printout options,
- Multi -language support
- Report management.
- PC keyboard and Mouse can be connected
- Software upgrade option.
- 9999 products possible to store in memory.
- designed for multiple use, such as Weighing, Target, Counting, Check weighing and Recipe operations.
- 2xUSB port, 1xRS232, optional more ports possible
- 7' or 8' display possible
- Robust ABS or stainless steel housing possible
- Dual scale option (extra charge) possibility



KPZ 51E-45K

IP69K

AISI 304 stainless steel weight Indicator (dimensions: 206x286x108 mm) with 6 PG9 cable glands, **IP69K protection rating**, stainless steel adjustable bracket included (overall dimensions with bracket: 206x290x187 mm). Optionals: panel / desk / column mounting. Six-key membrane keyboard with buzzer. Real-time clock with buffer battery.

Weight reading by another instrument via serial port.

Two serial ports (RS232 and RS485) for connection to:

- PC/PLC up to 32 instruments (max 99 with line repeaters) by ASCII protocol or ModBus RTU.
- Remote display.
- Printer.
- Optional integrated output: Profibus DP, DeviceNet, CANopen, Profinet IO, Ethernet/IP, Ethernet TCP/IP, Modbus/TCP.

Main functions:

- 5 setpoints (4 setpoints if Analog Output is present) configurable as normally open or normally closed. The operator can decide the setpoints activation for the net weight value, gross weight value, otherwise for positive weights or for positive and negative weights.
- Counting.
- Totalizing.
- Setting of hysteresis value for each setpoint.
- 12 groups selection by 5 setpoint from selector switch or contacts (EC/E options).
- Peak holder displaying by closing the Peak contact.
- Net/Gross function by keyboard or external contact.
- Manual adjustment of zero value in case of zero-setting not possible.
- Auto zero function.
- Auto zero-tracking function.
- Print of the weight via keyboard or external contact with date and time.

Operation: The inputs can work as: net/gross weight, zero-setting, peak, print or can be remotely read via protocol.

The outputs can work as setpoints or can be remotely switched via protocol.

Weight transmitter approved OIML R61 (Automatic Gravimetric Filling Instruments) according to WELMEC Guide 8.8:2011 (MID).

approvable EN45501-2014/31/UE-OIML R76:2006

- Maximum number of verification scale intervals n=10000
- Minimum input-voltage per VSI 0.2 μV
- Weighing range single range or multi range (max 3) or multi interval (max 3)
- Calibration via keyboard is protected through seals for the access to a setting jumper or installer password
- Semi-automatic zero and tare, predetermined tare functions.
- Weight subdivisions displaying (1/10 e)
- The following values can be printed from external contact: net/gross weight; tare; predetermined tare; date; time; ID code (if alibi memory is present)



KPZ 51E-41 indicator

Characteristics:

Software: Base

- Zeroing
- Tare
- Hand tare
- Gross / Net switching
- simple piece counting
- Add function
- automatic zeroing function

Function (Optional):

- Print function including date and time, external button
- I / O inputs as net / gross switching, zeroing, peak value, printout
- I / O outputs as set point function
- Communication protocol via serial interface
- 5 set points (4 set points if analogue output is available) Configurable as open or normally closed. The set points can be set as net weight, gross weight, for positive or for positive and negative weights.
- Setting the hysteresis value for each set point.

Option (extra charge):

- Wall mounting
- Stand
- Battery
- Alibi memory
- Analog output
- I/O's, relay output
- Printer
- Serial interface RS232 and RS485
- Remote display
- Profibus, Ethernet TCP/IP, Modbus, CANopen, DeviceNet.

Power supply:

- Mains 110-240VAC, 3m long cable

Technical Data:

- LCD display, backlit (6 digit 20mm high, semi alphanumeric)
- 16 icon displays
- Robust ABS housing IP67
- Temperature range: -10 ° C to 40 ° C
- dim. 122x226x164mm
- EU type approval Class III to 10,000e

Big display (second display), can be combined with all KPZ Indicator

Model : KPZ GD 1-1

150057052000 Large display KPZ GD1-1, 6-digit, 127 mm LED dot matrix, with 5m connection cable and interface for connection to the display KPZ 52 (E) - *

Model : KPZ GD 2

150057062000 Großanzeige KPZ GD2-1 6-stellig, 76 mm LED's dot Matrix, mit 5m Anschlußkabel und Interface zum Anschluß an die Anzeige KPZ 52 (E)-*



PC Software K-PZ Smart Scale

Software K-PZ Smart Scale is a modern software specially designed to manage weighing data. A custom function selection is possible depending on different stages of development. Moreover, it is possible to customize software according to customer requirements.

It provides an extremely user-friendly interface and easy of operation.

Software used to manage weighing data, transmitted via the interface of the scale.

It saves time and transmission errors that may occur by manual data input.

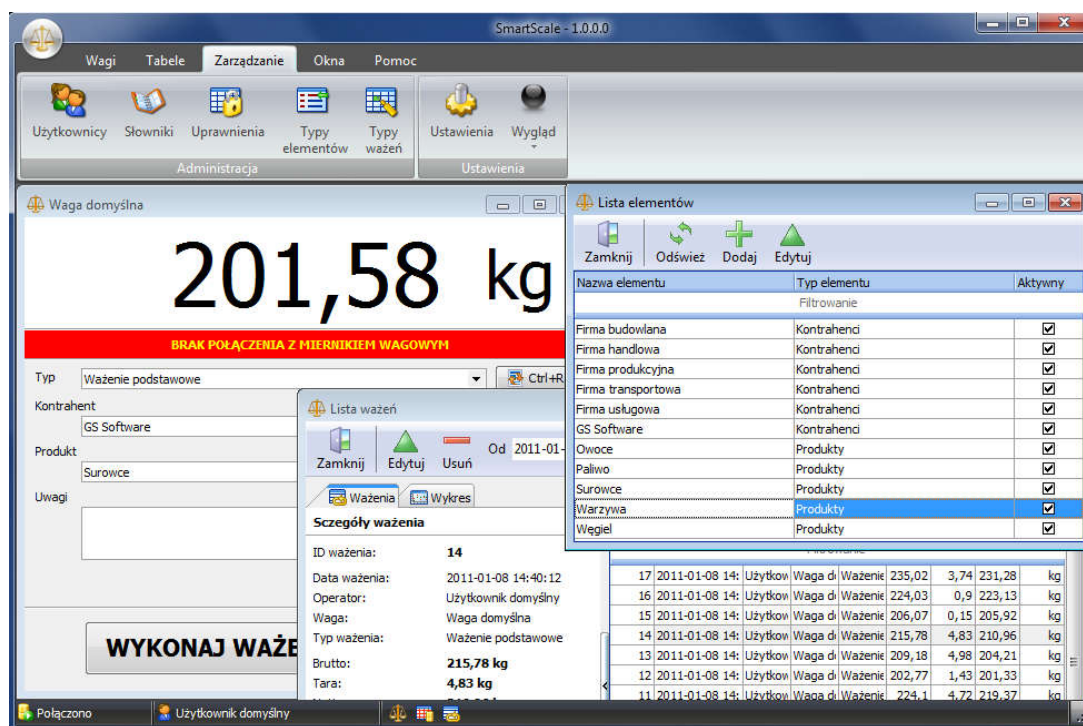

View of the main window

Depending on the configuration following option possible :

- Adjustment of customer-specific data
- Admin data managing
- User managing
- Export to TXT, CSV, RTF, JPG, XLS file
- Print out
- Label printing

Software comes with a USB flash drive activation key.

system Requirements:

Minimum requirements:

- hardware – Processor Intel Pentium 4, 512 MB RAM, 100 MB of the hard drive free;
- software: Windows 2000 (SP4), XP (SP2), Vista, Win7

Depending on version of KPZ Smart Scale , the following functionality is possible:

Function	Programm version		
	Standard	Professional	Premium
Facility to connect only one scale indicator	X		
Facility to connect any number of indicators the same time		X	X
Handling any model of KPZ indicator	X	X	X
Access to weighing list data window	X	X	X
Export weighing list data to the .TXT or .CSV file	X	X	X
Export weighing list data to the .XLS file (installation of MS Excel not necessary)		X	X
Weighing list data overview on the chart	X	X	X
Save the chart (weighing list data) as a picture	X	X	X
Weighing search	X	X	X
Weighing ticket preview	X	X	X
Save weighing ticket as PDF file	X	X	X
Edit data assigned to the weighing	X	X	X
History of weighing changes preview			X
Access to the Report Generator		X	X
Generating report to any data		X	X
Save the report as .PDF file		X	X
Export report data to .RTF, .CSV, .JPEG, XLS file (installation of MS Excel is necessary)		X	X
Export report data to . XLS file (installation of MS Excel not necessary)			X
Using programm as default user (with out Log in-Panel)	X		
Using programm as defined User or Admin		X	X
User Authorization Management			X
Facility to perform weighing without additional data	X	X	X
Facility to perform weighing with additional data: contractor, product, comments,	X	X	X
Facility to perform weighing with additional data: contractor, product, comments, + 2 additional dictionaries, + 2 additional text fields		X	X
Facility to perform weighting with any data type. Possibility to build any data structure.			X
Access to the window allowing to create dictionaries in a database			X
Network version		X	X
Print out as graphic or text mode	X	X	X
Facility to print out the logo on the ticket weighting (graphic mode)	X	X	X
Facility to create license data (one set only)	X		
Facility to create any number of license data set		X	X
Virtual Scales mechanism (planned)		X	X
Label ticket operation (planned)		X	X
Multi-language	X	X	X

Printers for KPZ scales

More printers and options on request!

Thermal printer Favorit 24	
Dimensions	85 x 85,5 mm (B x H)
Own weight	150 g
Power supply	Scale's battery
Interface	serial RS232
Version	Thermo-Direkt-Drucker, 203 dpi,
Paper	Paper width: 57 mm



Ticket printer DR 2	
Dimensions	93x173x190 mm (B x H x T)
Own weight	1,2 kg
Power supply	230 VAC / 20 V DC 2,5 A
Interface	serial RS232, Parallel
Version	Thermo-Direkt-Drucker, 203 dpi,
Paper	Etiquette width : max 61mm



Ticket printer DR 6	
Dimensions	ca. 109 x 171 x 209 mm (B x H x T)
Own weight	ca. 1,2 kg
Power supply	100-240 VAC / 24 VDC 2,1 A
Interface	seriell RS232, Parallel
Version	Thermo-Direkt-Drucker, 203 dpi,
Paper	Etiquette width: 15-60mm



Thermal printer Favorit	
Dimensions	85 x 85,5 mm (B x H)
Own weight	150 g
Power supply	Scale's battery
Interface	serial RS232
Version	Thermo-Direkt-Drucker, 203 dpi,
Paper	Paper width: 57 mm



Rollerprinter DR 7	NEW
Dimensions	110 x 125 x 70 mm (B x H x T)
Own weight	600 g
Power supply	230 VAC / 9 V DC 3,2 A
Interface	RS232, USB
Version	Thermo-Direkt
Paper	Papierbreite: 58mm, 20m, Ø40mm



Rollerprinter DR 7	
Dimensions	160 x 139 x 248 mm (B x H x T)
Own weight	2,3 kg
Power supply	230 VAC / 20 V DC 2,5 A
Interface	serial RS232, Parallel
Version	9- Needle printer, alphanumerischer Ausdruck
Paper	Paper width: 76 , 69,5 or 57,5 mm max. 40 digits on column



K-PZ Waagen
 Kanalsteck 9
 21129 Hamburg
 Tel. 040 / 742174-0
 Fax 040 / 742174-99
 TICKET NO. 1
 Art.-Nr.: 123456
 PCS 40
 APW 100 g
 G 5.001 kg
 T 1.000 kg
 N 4.001 kg



KPZ 719SJDR
 Exemplary formats
 Indikátor KPZ 52 19



TICKET NO.0001
 GS 124.5 kg
 TR 20.0 kg
 NT 104.5 kg

TICKET NO.0002
 GS 124.0 kg
 TR 20.0 kg
 NT 104.0 kg

TOTAL NUMBER
 OF TICKETS 0002
 TOTAL WEIGHT
 248.5 kg

Indicator KPZ 5218



23/08/2016, 16:42:45

TICKET NO.0001
 G 2.0kg
 T 0.0kg
 N 2.0kg

23/08/2016, 16:43:01

TICKET NO.0002
 G 5.6kg
 T 0.0kg
 N 5.6kg

23/08/2016, 16:43:13

TOTAL NUMBER
 OF TICKETS 0002
 TOTAL
 NET 7.6kg

KPZ printers

Exemplary formats / Indicator KPZ 52(E) – 7 / Indicator KPZ 52(E) - 8

Examples are standard formats to printers KPZ. Possibility computer formats. Possibility of formats on customer request!

Exemplary print out Simple format 3	
S/N	WT/kg
0001	100,0
0002	200,0
0003	300,0
0003	600,0

Exemplary print out Complete format 4	
TICKET NO.0001	
G	100,0g
T	0,0g
N	100,0g
TICKET NO.0002	
G	200,0g
T	0,0g
N	200,0g
TICKET NO.0003	
G	300,0g
T	0,0g
N	300,0g
TOTAL NUMBER OF TICKETS 0003	
TOTAL	
NET	600,0g

G = Gross
T = Tare
N = Netto

Exemplary print out Stable format 5	
S/N	WT/kg
0001	100,0
0002	200,0
0003	300,0
0003	600,0

KPZ printers

Exemplary formats / Indicator KPZ 56-3/ KPZ 56-4 / KPZ 2-04-7 scale

Examples are the standard formats. Other formats are possible on request.

Example - format 1:

20.000	kg
7.975	kg
12.125	kg
13.380	kg

Example - format 2:

Ticket NO.	1	
Q'TY	40	PCS
APW	100	g
G/B	5.000	kg
T	1.000	kg
N	4.000	kg

Ticket NO.	2	
Q'TY	290	PCS
APW	100	g
G/B	30.000	kg
T	1.000	kg
N	29.000	kg

TOTAL TICKETS:	2
TOTAL Q'TY:	330 PCS

Example - format 3:

Date:	03-03-00	
Time:	09:04:43	
ID#:	123456789012345	
Part#:	543210987654321	
Ticket NO.	1	
Q'TY	40	PCS
APW	100	g
G/B	5.000	kg
T	1.000	kg
N	4.000	kg

Date:	03-03-00	
Time:	09:04:43	
ID#:	123456789012345	
Part#:	543210987654321	
Ticket NO.	2	
Q'TY	290	PCS
APW	100	g
G/B	30.000	kg
T	1.000	kg
N	29.000	kg

TOTAL TICKETS:	2
TOTAL Q'TY:	330 PCS

Example - format 4:

S/N	WT/kg	PCS
1.	20.000	3333
2.	20.000	3333
3.	8.000	1333
3/	TOTAL	Q'TY:
	7999	PCS

Example - format 5:

Date:	03-03-00	
Time:	09:04:43	
ID#:	123456789012345	
Part#:	543210987654321	
S/N	WT/kg	PCS
1.	20.000	3333
2.	20.000	3333
3.	8.000	1333
3/	TOTAL	Q'TY:
	7999	PCS

Printing formats

Indicator KPZ 56E-3 / KPZ 56E-4

Scale KPZ 2-04E-7

inkl. PT and Addition

standard format

NO.	1
G	276.7 kg
T	104.5 kg
PT	22.2 kg
N	150.0 kg
U/W	12 kg
PCS	13 pcs

NO.	2
G	176.7 kg
T	104.5 kg
PT	22.2 kg
N	50.0 kg
U/W	12 kg
PCS	4 pcs

=====	
T/N	2
T/W	200.0 kg
T/A	17 pcs

PT = Pretare

U/W = Unit Weight
 PCS = Quantity

T/N = Total weighings
 T/W= Total Netto weight
 T/A= Total quantity

Indicator KPZ 51E-9-2

Example - format 1:

DATE:	03/03/2000
TIME:	09:04:43
TICKET NO.	01
NET:	+ 4.500 kg
GROSS:	+ 6.000 kg
TARE:	+ 1.000 kg
PRETARE:	+ 0.500 kg

DATE:	03/03/2000
TIME:	09:04:55
TICKET NO.	02
NET:	+ 5.500 kg
GROSS:	+ 6.000 kg
TARE:	+ 0.000 kg
PRETARE:	+ 0.500 kg

DATE:	03/03/2000
TIME:	09:05:35
TOTAL NO.	02
TOTAL NET:	+ 5.500 kg



KPZ 2-11-3 **M**

KPZ 2-02-4 **M**

KPZ 2-03-10 **M** IP 65

KPZ 2-04-7 **M**

KPZ 2E-06S **M** **Ex**

KPZ 2114

KPZ 2082 Dual counting System

KPZ 1 **M** **Ex**

KPZ 1 B **M**

KPZ 2B **M**

KPZ 2S **M**

KPZ 2ECO **M**

Drive throught Scale

KPZ 2D **M** **Ex**

KPZ 71-* **M** **Ex**

Stainless Steel DIN 1.4301, extrem solid and stable construction, IP 67, 68 and 69K



KPZ 72 **M** **Ex**

KPZ 73B

KPZ 73SDJ

KPZ 73 **M**

KPZ 74 **M**

KPZ 76 **M** weighing Forks



KPZ 39
 Hydraulic scale



Crane scale **M**



Coil Scale



Animal scale **M**



Silo weighing





KPZ PC Software



Special models are our speciality!

Mobile KPZ scales



KPZ 71-7   
 Many Option possible



Option KPZ 71-7



KPZ 71-8 
 2.200kg / 200g



KPZ 71-9
 2.200kg / 500g



KPZ 72 



KPZ 72, 2400mm, 3200kg



KPZ 73 



KPZ 73 SDJ 



KPZ 73 B 



KPZ 74 



Weighing forks Forklift truck scale



KPZ 39
 Electronic – Hydraulic version



Touch sreen Indicator 7-Zoll



Scale for Coil's



German design and own EU production guarantees high quality.

Stainless steel Material : DIN 1.4301 / 1.4541 / 1.4404

KPZ-Waagen, Stainless steel scale and Indicator, IP 67/68/69K



Platform Scale KPZ 2N, Stainless steel, IP 67/68/69 K

Stainless steel Material : DIN 1.4301 / 1.4541 / 1.4404

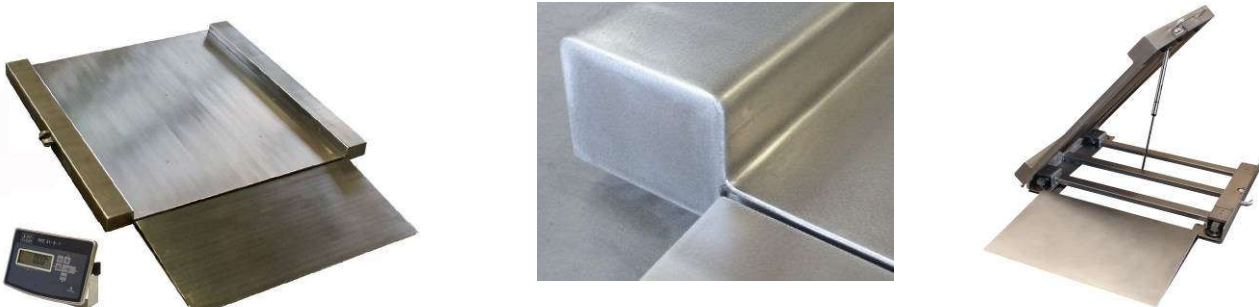

Low construction scale KPZ 2DN

Plain, top plate of platform made of one piece. IP 67/68/69K

Stainless steel Material : DIN 1.4301 / 1.4541 / 1.4404



**Pallet weigher Type: KPZ 71-7N
stainless steel DIN 1.430, IP 67/68/69K**

**Pallet scale KPZ 1N, IP 67/68/69K
Stainless steel - Material 1.4301**



**Bench Scale KPZ 2E-06, stainless steel DIN 1.430, IP 67/68, IP 69K
German design and own EU production guarantees high quality.**

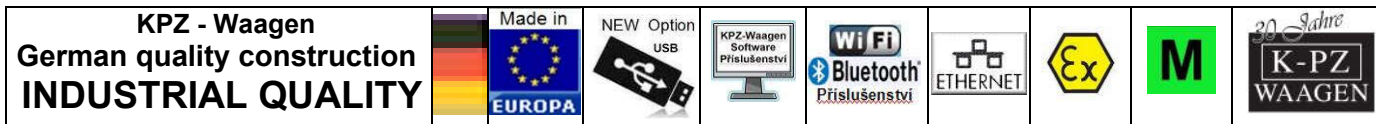

200400 00 N UK €



KPZ - Váhy, s. r. o.

Libošovice 76,
CZ 507 44 Libošovice

Tel.:

+420 736 622 710

+48 661 033 820

+420 493 571 111

email: / zander@kpzwaagen.de / kpz@kpz-vahy.cz

www.kpzwaagen.com