

KPZ 1N / Pallet scales

Stainless steel, DIN 1.4301 / IP67/68 and IP 69K

Solid Pallet scales for industrial use



IP 69 K

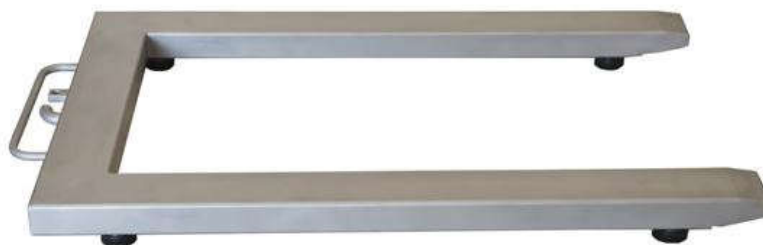

Solid and stable U-Form scales series **KPZ 1N, IP 67**. **German design and own EU production guarantees high quality**. Designed as floor scales, for food and Chemical industrial weighing. High accuracy. Maintenance-free durable Stainless steel (DIN 1.4301) construction. High quality polishing standard.

Construction: Robust, maintenance-free, welded steel construction, heavy duty design for food and chemical industrial use, **Stainless steel** weighing platform, Maintenance-free durable Stainless steel (DIN 1.4301)

Load cells: Robust, **stainless steel load cell**, IP68, OIML, with a high overload capacity. **Levelling feet**.

Installation: Adjustable leveling feet, designed for permanent or portable installations, 5m cable to connect digital indicator. **Options:** Extra ramps, Base anchors, Wall mounting for indicator, Indicator stand, Custom sizes and capacities. **Standard indicator:** KPZ 52E91, **For approved applications:** KPZ 52E91, **Options for indicators:** Multi range, RS 232 serial interface, Various printers connection, Radio data transfer, WLAN, etc..

Internal battery. **Approvals:** OIML class III **M**, CE conform. **Power Supply** : 230 V mains, Power cord

Typ	Capacity	Div.	Dim. mm.	Approval possibility	Indicator	Art.-No
KPZ 1ENM	600/1500 kg	200/500 g	840 x 1260	YES	KPZ 52E91/IP67	1NM000000150E
KPZ 1EN	600 kg	200 g	840 x 1260	YES	KPZ 52E91/IP67	1N0000000060E
KPZ 1EN	1500 kg	500 g	840 x 1260	YES	KPZ 52E91/IP67	1N0000000150E
KPZ 1EN	2000 kg	1000 g	840 x 1260	YES	KPZ 52E91/IP67	1N0000000200E
KPZ 1NM	1500/2000 kg	500/1000 g	840 x 1260	No	KPZ 52E91/IP67	1NM0000002000
KPZ 1EN	3000 kg	1000 g	840 x 1260	YES	KPZ 52E91/IP67	1N0000000300E
KPZ 1NM	1500/3000 kg	500/1000 g	840 x 1260	No	KPZ 52E91/IP67	1NM0000003000

KPZ price includes complete scale with indicator.

Low plate and ramp 	Low plate with holders and ramp, 	Additional top plate 	Extended load-arms 	Grip, tilt and drive off 	Drive under and leave
------------------------	--------------------------------------	--------------------------	------------------------	------------------------------	---------------------------

Construction-options	Art.-NO
1.)Low plate and ramp for easy loading capacity max. 2000 lb	11001000000L
2.)Low plate with holders and ramp, special dimension capacity 5000 lb	On request
3.)Additional top plate for weighing smaller items	1N000800000L
4.)Extended load-arms for non standard pallets	1N001100000L
5.)Stand allowing easy scale transport	1N040000000L
6.)Stand allowing easy scale transport fastened to the scale	1N050000000L

... please contact us for special requests!

Stainless steel Material : DIN 1.4301 / 1.4541 / 1.4404 / IP 67/68 + IP 69K



KPZ-Waagen Stainless steel scale Program

German design and own EU production guarantees high quality.

Stainless steel Material : DIN 1.4301 / 1.4541 / 1.4404 / IP 67/68 + IP 69K

 <p>KPZ 1N/ IP67/68 / IP 69K</p>	 <p>KPZ 717 N IP67/68 / IP 69K</p>	 <p>KPZ 2E06N / váha IP67/68 / IP 69K</p>	
 <p>KPZ 2N / IP67/68 / IP 69K</p>	 <p>KPZ 2N / IP67/68 / IP 69K Hygienic design (option) - Hermetically sealed profile - Open construction for easy cleaning - Gas pressure spring</p>	 <p>KPZ 2NL / IP67/68 / IP 69K</p>	
 <p>KPZ 2DN / IP67/68 / IP 69K</p>	 <p>KPZ 2DN / IP67/68 / IP 69K Capacity up to 3.000kg</p>	 <p>KPZ 2E-07-2N  Wall folding scale Stainless steel, DIN 1.4301 / IP67/68 and IP 69K</p>	
 <p>KPZ 52E91  </p>	 <p>KPZ 51E92  </p>	 <p>KPZ 51E-45K, IP 69 K  </p>	 <p>KPZ 54E-*  </p>

... please contact us for special requests!



KPZ 1N / Pallet scales

Stainless steel, DIN 1.4301 / IP67/68 and IP 69K

Solid Pallet scales for industrial use



IP 69 K

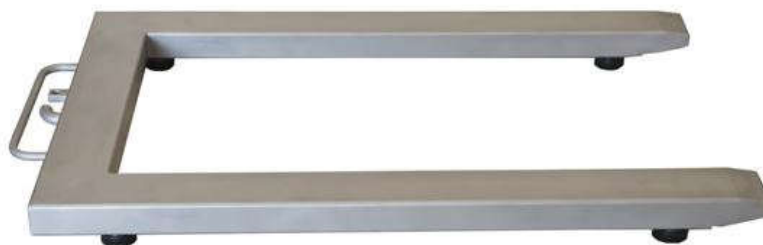

Solid and stable U-Form scales series **KPZ 1N, IP 67**. **German design and own EU production guarantees high quality**. Designed as floor scales, for food and Chemical industrial weighing. High accuracy. Maintenance-free durable Stainless steel (DIN 1.4301) construction. High quality polishing standard.

Construction: Robust, maintenance-free, welded steel construction, heavy duty design for food and chemical industrial use, **Stainless steel** weighing platform, Maintenance-free durable Stainless steel (DIN 1.4301)

Load cells: Robust, **stainless steel load cell**, IP68, OIML, with a high overload capacity. **Levelling feet**.

Installation: Adjustable leveling feet, designed for permanent or portable installations, 5m cable to connect digital indicator. **Options:** Extra ramps, Base anchors, Wall mounting for indicator, Indicator stand, Custom sizes and capacities. **Standard indicator:** KPZ 52E91, **For approved applications:** KPZ 52E91, **Options for indicators:** Multi range, RS 232 serial interface, Various printers connection, Radio data transfer, WLAN, etc..

Internal battery. **Approvals:** OIML class III **M**, CE conform. **Power Supply** : 230 V mains, Power cord

Typ	Capacity	Div.	Dim. mm.	Approval possibility	Indicator	Art.-No
KPZ 1ENM	600/1500 kg	200/500 g	840 x 1260	YES	KPZ 52E91/IP67	1NM000000150E
KPZ 1EN	600 kg	200 g	840 x 1260	YES	KPZ 52E91/IP67	1N0000000060E
KPZ 1EN	1500 kg	500 g	840 x 1260	YES	KPZ 52E91/IP67	1N0000000150E
KPZ 1EN	2000 kg	1000 g	840 x 1260	YES	KPZ 52E91/IP67	1N0000000200E
KPZ 1NM	1500/2000 kg	500/1000 g	840 x 1260	No	KPZ 52E91/IP67	1NM0000002000
KPZ 1EN	3000 kg	1000 g	840 x 1260	YES	KPZ 52E91/IP67	1N0000000300E
KPZ 1NM	1500/3000 kg	500/1000 g	840 x 1260	No	KPZ 52E91/IP67	1NM0000003000

KPZ price includes complete scale with indicator.

Low plate and ramp 	Low plate with holders and ramp, 	Additional top plate 	Extended load-arms 	Grip, tilt and drive off 	Drive under and leave
------------------------	--------------------------------------	--------------------------	------------------------	------------------------------	---------------------------

Construction-options	Art.-NO
1.)Low plate and ramp for easy loading capacity max. 2000 lb	11001000000L
2.)Low plate with holders and ramp, special dimension capacity 5000 lb	On request
3.)Additional top plate for weighing smaller items	1N000800000L
4.)Extended load-arms for non standard pallets	1N001100000L
5.)Stand allowing easy scale transport	1N040000000L
6.)Stand allowing easy scale transport fastened to the scale	1N050000000L

... please contact us for special requests!

Stainless steel Material : DIN 1.4301 / 1.4541 / 1.4404 / IP 67/68 + IP 69K



KPZ 2N / Platform Scales

Stainless steel Material : DIN 1.4301 / 1.4541 / 1.4404 / IP 67/68 + IP 69K

For continuous operation / Better quality: approved components !!!











KPZ 51E-45K, IP 69 K M

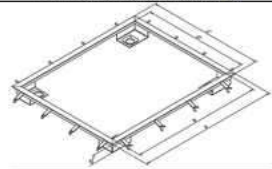

KPZ 52E91

Hygienic design (option)

 <p>Open construction for easy cleaning</p>	 <p>Hermetically sealed profile</p>	 <p>Gas pressure spring</p>	 <p>Safety Frame for KPZ 2</p>
 <p>Forklift fork shoes</p>	 <p>Elevated frame</p>	 <p>Pit Frame</p>	 <p>Ramp for KPZ 2</p>

Solid and stable platform scales series [KPZ 2N IP 67](#). **German design and own EU production guarantees high quality.** Designed as floor scales, for **food and Chemical** industrial weighing. High accuracy. Maintenance-free durable Stainless steel (DIN 1.4301) construction. High quality polishing standard.

Construction: Robust, maintenance-free, welded stainless steel construction, heavy duty design for **food and chemical** industrial use, **Stainless steel** weighing platform, Maintenance-free durable Stainless steel (DIN 1.4301)

Load cells: Robust, **stainless steel load cell**, IP68, OIML, with a high overload capacity. **Levelling feet.**

Installation: Adjustable leveling feet, designed for permanent or portable installations, 5m cable to connect digital indicator.

Options: Extra ramps, Base anchors, Wall mounting for indicator, Indicator stand, Custom sizes and capacities

Standard indicator: [KPZ 52E91](#), **For approved applications:** [KPZ 52E91](#), **Options for indicators:** Multi range, RS 232 serial interface, Various printers connection, Bluetooth data transfer, WLAN, etc.. Internal battery

Approvals: OIML class III , CE conform. **Power Supply** : 230 V mains, Power cord.

Hygienic design (option) : Hermetically sealed profile, Open construction for easy cleaning, - Gas pressure spring.

Special requirements for unique loading - please contact us for more information!

Stainless steel Material : DIN 1.4301 / 1.4541 / 1.4404 / IP 67/68 + IP 69K



Special models are our speciality!

Type	Kapazität	Teilung	Abm. mm		Article-Nr
KPZ 2EN	300 kg	100 g	800 x 800	Yes (III) M	2N000808030E
KPZ 2EN	600 kg	200 g	800 x 800	Yes (III) M	2N000808060E
KPZ 2NM	750/1500 kg	200/500 g	800 x 800	No	2NM008081500
KPZ 2EN	1500 kg	500 g	800 x 800	Yes (III) M	2N000808150E
KPZ 2EN	300 kg	100 g	1000 x 1000	Yes (III) M	2N001010030E
KPZ 2EN	600 kg	200 g	1000 x 1000	Yes (III) M	2N001010060E
KPZ 2NM	750/1500 kg	200/500 g	1000 x 1000	No	2NM010101500
KPZ 2EN	1500 kg	500 g	1000 x 1000	Yes (III) M	2N001010150E
KPZ 2EN	1500 kg	500 g	1000 x 1250	Yes (III) M	2N001012150E
KPZ 2EN	1500 kg	500 g	1250 x 1250	Yes (III) M	2N001212150E
KPZ 2EN	3000 kg	1000 g	1250 x 1250	Yes (III) M	2N001212300E
KPZ 2NM	1500/3000 kg	500/1000 g	1250 x 1250	No	2NM012123000
KPZ 2EN	1500 kg	500 g	1250 x 1500	Yes (III) M	2N001215150E
KPZ 2EN	3000 kg	1000 g	1250 x 1500	Yes (III) M	2N001215300E
KPZ 2NM	1500/3000 kg	500/1000 g	1250 x 1500	No	2NM012153000
KPZ 2EN	1500 kg	500 g	1500 x 1500	Yes (III) M	2N001515150E
KPZ 2EN	3000 kg	1000 g	1500 x 1500	Yes (III) M	2N001515300E
KPZ 2NM	1500/3000 kg	500/1000 g	1500 x 1500	No	2NM015153000
KPZ 2EN	3000 kg	1000 g	1500 x 2000	Yes (III) M	2N001520300E
KPZ 2NM	1500/3000 kg	500/1000 g	1500 x 2000	No	2NM015203000

Der Preis ist für die Komplette Waage einschl. Anzeige

Option / Einbaurahmen		
Pitframe for KPZ 2N, 800 x 800 mm up to 3t		25N008083000
Pitframe for KPZ 2N, 1000 x 1000 mm up to 3t		25N010103000
Pitframe for KPZ 2N, 1000 x 1250 mm up to 3t		25N010123000
Pitframe for KPZ 2N, 1250 x 1250 mm up to 3t		25N121230000
Pitframe for KPZ 2N, 1250 x 1500 mm up to 3t		25N121530000
Pitframe for KPZ 2N; 1500 x 1500 mm up to 3t		25N015153000
Pitframe for KPZ 2N, 1500 x 2000 mm up to 3t		25N015203000

Option Rampe KPZ 2N (Edelstahl)	Rampen Abm.		
KPZ 2N 800 x 800 mm up to 3t	800 mm wide, 800 mm long		21N008083000
KPZ 2N 1000 x 1000 mm up to 3t	1000 mm wide, 800 mm long		21N008103000
KPZ 2N 1000 x 1250 mm up to 3t	1000 mm wide, 800 mm long		21N008103000
KPZ 2N 1250 x 1250 mm up to 3t	1250 mm wide, 800 mm long		21N008123000
KPZ 2N 1250 x 1500 mm up to 3t	1250 mm wide, 800 mm long		21N008123000
KPZ 2N 1500 x 1500 mm up to 3t	1500 mm wide, 800 mm long		21N008153000
KPZ 2N 1500 x 1500 mm up to 3t	1500 mm wide, 1500 mm long		21N015153000

Packing dimension	scale capacity	packing dimension
KPZ 2 N 800 x 800	Up to 1500kg	80 x 120 x 50 cm, 80 kg
KPZ 2 N 1000 x 1000	Up to 1500kg	130 x 100 x 50 cm, 100 kg
KPZ 2 N 1000 x 1250	Up to 1500kg	130 x 100 x 50 cm, 100 kg
KPZ 2 N 1250 x 1250	Up to 3000kg	130 x 135 x 50 cm 135 kg
KPZ 2 N 1250 x 1500	Up to 3000kg	130 x 160 x 50 cm. 160 kg
KPZ 2 N 1500 x 1500	Up to 3000kg	160 x 160 x 50 cm 190 kg
KPZ 2 N 1500 x 2000	Up to 3000kg	160 x 200 x 50 cm 330 kg

... please contact us for special requests!

Stainless steel Material : DIN 1.4301 / 1.4541 / 1.4404 / IP 67/68 + IP 69K





































KPZ 2NG / Platform Scales

**Hygienic design, Hermetically sealed profile,
Opening construction for easy cleaning, - Gas pressure spring.**

Stainless steel Material : DIN 1.4301 / 1.4541 / 1.4404 / IP 67/68 + IP 69K

For continuous operation / Better quality: approved components !!!



Typ	Capacity	Div.	Dim. mm.	Approval possibility	Indicator	Art.-No
KPZ 2ENG	300 kg	100 g	800 x 800	Yes  	KPZ 52E91/IP67	2NG00808030E
KPZ 2ENG	600 kg	200 g	800 x 800	Yes  	KPZ 52E91/IP67	2NG00808060E
KPZ 2NMG	750/1500 kg	200/500 g	800 x 800	No	KPZ 52E91/IP67	2NMG08081500
KPZ 2ENG	1500 kg	500 g	800 x 800	Yes  	KPZ 52E91/IP67	2NG00808150E
KPZ 2ENG	300 kg	100 g	1000 x 1000	Yes  	KPZ 52E91/IP67	2NG01010030E
KPZ 2ENG	600 kg	200 g	1000 x 1000	Yes  	KPZ 52E91/IP67	2NG01010060E
KPZ 2NMG	750/1500 kg	200/500 g	1000 x 1000	No	KPZ 52E91/IP67	2NMG10101500
KPZ 2ENG	1500 kg	500 g	1000 x 1000	Yes  	KPZ 52E91/IP67	2NG01010150E
KPZ 2ENG	600 kg	500 g	1000 x 1250	No	KPZ 52E91/IP67	2NG010121500
KPZ 2ENG	1500 kg	500 g	1000 x 1250	Yes  	KPZ 52E91/IP67	2NG01012150E
KPZ 2ENG	2000 kg	1000 g	1000 x 1250	Yes  	KPZ 52E91/IP67	2NG010122000
KPZ 2ENG	600 kg	200 g	1250 x 1250	No	KPZ 52E91/IP67	2NG012121500
KPZ 2ENG	1500 kg	500 g	1250 x 1250	Yes  	KPZ 52E91/IP67	2NG01212150E
KPZ 2ENG	3000 kg	1000 g	1250 x 1250	Yes  	KPZ 52E91/IP67	2NG01212300E
KPZ 2NMG	1500/3000 kg	500/1000 g	1250 x 1250	No	KPZ 52E91/IP67	2NMG12123000
KPZ 2ENG	600 kg	200 g	1250 x 1500	Yes  	KPZ 52E91/IP67	2NG012150600
KPZ 2ENG	1500 kg	500 g	1250 x 1500	Yes  	KPZ 52E91/IP67	2NG01215150E
KPZ 2ENG	2000 kg	1000 g	1250 x 1500	Yes  	KPZ 52E91/IP67	2NG01215150E
KPZ 2ENG	3000 kg	1000 g	1250 x 1500	Yes  	KPZ 52E91/IP67	2NG01215300E
KPZ 2NMG	1500/3000 kg	500/1000 g	1250 x 1500	No	KPZ 52E91/IP67	2NMG12153000
KPZ 2ENG	1500 kg	500 g	1500 x 1500	Yes  	KPZ 52E91/IP67	2NG01515150E
KPZ 2ENG	3000 kg	1000 g	1500 x 1500	Yes  	KPZ 52E91/IP67	2NG01515300E
KPZ 2NMG	1500/3000 kg	500/1000 g	1500 x 1500	No	KPZ 52E91/IP67	2NMG15153000
KPZ 2ENG	3000 kg	1000 g	1500 x 2000	Yes  	KPZ 52E91/IP67	2NG01520300E
KPZ 2NMG	1500/3000 kg	500/1000 g	1500 x 2000	No	KPZ 52E91/IP67	2NMG15203000

... please contact us for special requests!

Stainless steel Material : DIN 1.4301 / 1.4541 / 1.4404 / IP 67/68 + IP 69K



KPZ 2DN / Low construction scales / Stainless steel / IP67/68 and IP 69K Plain, top plate of platform made of one piece



Indicator KPZ 52E-9-1, Stainless steel housing IP 67, 6 digit 25 mm high LCD-Display, with backlight function, large function keys
Pre-set / limit value control, Simple piece counting
EC approved class III up to 10.000 e

Solid and stable platform scales series [KPZ 2 DN IP 67](#). **German design and own EU production guarantees high quality.** Designed as floor scales, for food and Chemical industrial weighing. High accuracy. Maintenance-free durable Stainless steel (DIN 1.4301 / IP67/68 / 69K) construction. High quality polishing standard

Construction: Robust, maintenance-free, welded stainless steel construction, heavy duty design for food industrial use, **Stainless steel** weighing platform, Maintenance-free durable Stainless steel (DIN 1.4301 / IP67/68 / IP69K). **Load cells:** Robust, **stainless steel load cell**, IP68, OIML, with a high overload capacity. **Levelling feet.**

Installation: Adjustable leveling feet, designed for permanent or portable installations, 5m cable to connect digital indicator. **Options:** Extra ramps, Base anchors, Wall mounting for indicator, Indicator stand, Custom sizes and capacities.

Typ	Kapazität	Teilung	Abm. /mm	Eichf.	Anzeige	Art.-No
KPZ 2DN	150 kg	50 g	800 x 800 x 45	YES	KPZ 52E91/IP67	2DN00808015E
KPZ 2DNM	150/300 kg	50/100 g	800 x 800 x 45	No	KPZ 52E91/IP67	2DNM08080300
KPZ 2DN	300 kg	100 g	800 x 800 x 45	YES	KPZ 52E91/IP67	2DN00808030E
KPZ 2DN	600 kg	200 g	800 x 800 x 45	YES	KPZ 52E91/IP67	2DN00808060E
KPZ 2DNM	300/600 kg	100/200 g	800 x 800 x 45	No	KPZ 52E91/IP67	2DNM08080600
KPZ 2DNM	750/1500 kg	200/500 g	800 x 800 x 45	Ne	KPZ 52E91/IP67	2DNM08081500
KPZ 2DN	600 kg	200 g	1060 x 1250 x 45	YES	KPZ 52E91/IP67	2DN01112060E
KPZ 2DNM	750/1500 kg	200/500 g	1060 x 1250 x 45	No	KPZ 52E91/IP67	2DNM11121500
KPZ 2DN	1500 kg	500 g	1060 x 1250 x 45	YES	KPZ 52E91/IP67	2DN01112150E
KPZ 2DN	600 kg	200 kg	1250 x 1250 x 45	YES	KPZ 52E91/IP67	2DN01212060E
KPZ 2DNM	750/1500 kg	200/500 g	1250 x 1250 x 45	No	KPZ 52E91/IP67	2DNM12121500
KPZ 2DN	1500 kg	500 g	1250 x 1250 x 45	YES	KPZ 52E91/IP67	2DN01212150E
KPZ 2DN	600 kg	200 kg	1250 x 1500 x 45	YES	KPZ 52E91/IP67	2DN01215060E
KPZ 2DNM	750/1500 kg	200/500 g	1250 x 1500 x 45	No	KPZ 52E91/IP67	2DNM12151500
KPZ 2DN	1500 kg	500 g	1250 x 1500 x 45	YES	KPZ 52E91/IP67	2DN01215150E
KPZ 2DN	600 kg	200 kg	1500 x 1500 x 45	YES	KPZ 52E91/IP67	2DN01515060E
KPZ 2DNM	750/1500 kg	200/500 g	1500 x 1500 x 45	No	KPZ 52E91/IP67	2DNM15151500
KPZ 2DN	1500 kg	500 g	1500 x 1500 x 45	YES	KPZ 52E91/IP67	2DN01515150E

7 KPZ price includes complete scale with indicator and 1 Ramp.

KPZ-Váhy s.r.o. • Libošovice 76 • CZ507 44 Libošovice • GSM:00420736622710 • Email: zander@kpzwaagen.de •
KPZ-Waagen - 30years - AFFORDABLE, ROBUST and GOOD !! www.kpzwaagen.com

We reserve the right to make technical modifications and price changes without prior notification. Warranty: The parts and components are warranted for **two years** from the date of delivery against defects in materials and workmanship, provided proper and normal use condition, excluding batteries and chargers.

Diameter typ KPZ 2DN

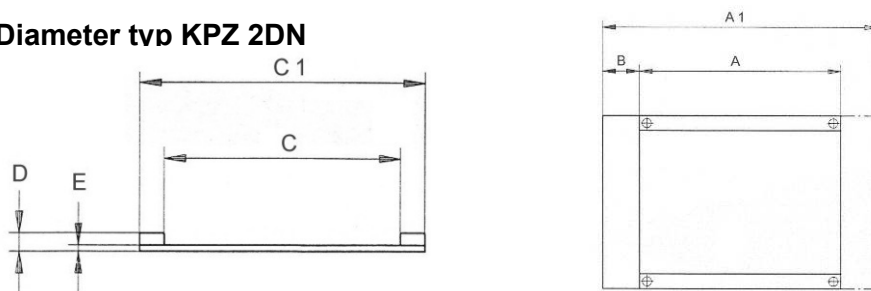

Capacity	Dim.	A	A1	B	C	C1	D	E
600kg	800 x 800	800	1800	500	800	1040	80	45
1500kg	1250 x 1060	1250	2250	500	1060	1300	80	45
1500kg	1250 x 1250	1250	2250	500	1250	1490	80	45
1500kg	1250 x 1500	1500	2500	500	1250	1490	80	45

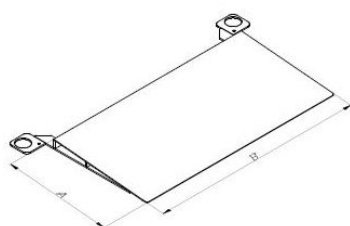

Ramp for KPZ 2 DN	A/mm	B/mm	Art. nr
Ramp for KPZ 2 DN, 800 mm	500	800	21DN05081200
Ramp for KPZ 2 DN, 1060 mm	500	1060	21DN05111500
Ramp for KPZ 2 DN, 1250 mm	500	1250	21DN05121500
Ramp for KPZ 2 DN, 1500 mm	500	1500	21DN05151500

Go through stop			
Go through stop for KPZ 2 DN dim. 800 x 800 mm			2DN001101500
Go through stop for KPZ 2 DN dim. 1250 x 1060 mm			2DN000131500
Go through stop for KPZ 2 DN dim. 1250 x 1500 mm			2DN001151500
Go through stop for KPZ 2 DN dim. 1500 x 1500 mm			2DN001171500

... please contact us for special requests!

Solid Low construction scales for industrial use

Better quality: approved components !!!

German design and own EU production guarantees high quality.

Stainless steel Material : DIN 1.4301 / 1.4541 / 1.4404 / IP 67/68 + IP 69K

Weighing range from 0 up to 6.000 kg



KPZ 2DNG / Low construction scales

Hygienic design, Hermetically sealed profile,

Opening construction for easy cleaning, - Gas pressure spring.

Stainless steel Material : DIN 1.4301 / 1.4541 / 1.4404 / IP 67/68 + IP 69K

For continuous operation / Better quality: approved components !!!

Plain, top plate of platform made of one piece



Typ	Capacity kg	Div. g	Dim. mm.	Approval possibility	Indicator	Art.-No
KPZ 2DNG	300 kg	100 g	800 x 800 x 45	YES	KPZ 52E91/IP67	2DNG0808030E
KPZ 2DNG	600 kg	200 g	800 x 800 x 45	YES	KPZ 52E91/IP67	2DNG0808060E
KPZ 2DNMG	300/600	100/200	800 x 800 x 45	No	KPZ 52E91/IP67	2DNG080806M0
KPZ 2DNMG	750/1500	200/500	800 x 800 x 45	No	KPZ 52E91/IP67	2DNG080815M0
KPZ 2DNG	600 kg	200 g	1060 x 1250 x 45	YES	KPZ 52E91/IP67	2DNG1112060E
KPZ 2DNMG	750/1500	200/500	1060 x 1250 x 45	No	KPZ 52E91/IP67	2DNG111215M0
KPZ 2DNG	1500 kg	500 g	1060 x 1250 x 45	YES	KPZ 52E91/IP67	2DNG1112150E
KPZ 2DNG	600 kg	200 g	1250 x 1250 x 45	YES	KPZ 52E91/IP67	2DNG1212060E
KPZ 2DNMG	750/1500	200/500	1250 x 1250 x 45	No	KPZ 52E91/IP67	2DNG121215M0
KPZ 2DNG	1500 kg	500 g	1250 x 1250 x 45	YES	KPZ 52E91/IP67	2DNG1212150E
KPZ 2DNG	600 kg	200 g	1250 x 1500 x 45	YES	KPZ 52E91/IP67	2DNG1215060E
KPZ 2DNMG	750/1500	200/500	1250 x 1500 x 45	No	KPZ 52E91/IP67	2DNG121515M0
KPZ 2DNG	1500 kg	500 g	1250 x 1500 x 45	YES	KPZ 52E91/IP67	2DNG1215150E
KPZ 2DNG	600 kg	200 g	1500 x 1500 x 45	YES	KPZ 52E91/IP67	2DNG1515060E
KPZ 2DNMG	750/1500	200/500	1500 x 1500 x 45	No	KPZ 52E91/IP67	2DNG151515M0
KPZ 2DNG	1500 kg	500 g	1500 x 1500 x 45	YES	KPZ 52E91/IP67	2DNG1515150E

KPZ price includes complete scale with indicator and 1 Ramp.

.....pls contact us for special request !

German design and own EU production guarantees high quality.

Stainless steel Material : DIN 1.4301 / 1.4541 / 1.4404 / IP 67/68 + IP 69K



KPZ 2E06N / Bench Scale

Stainless steel, DIN 1.4301 / IP67/68 and IP 69K

For continuous operation / Better quality: approved components !!!



KPZ 52E91, IP 67



KPZ 51E-45K, IP 69 K

Solid and stable platform scales series **KPZ 2E06N**. **German design and own EU production guarantees high quality**. Designed as Bench scales, for **Food and chemical** industrial weighing. High accuracy. Maintenance-free durable **Stainless steel, DIN 1.4301/ IP67/68 / IP69K** construction. High quality polishing Standard.

Construction: Robust, maintenance-free, welded steel construction, heavy duty design for food industrial use, **Stainless steel** weighing platform, Maintenance-free durable **Stainless steel (DIN 1.4301 / IP67/68 /**

Load cells: Robust, **stainless steel load cell, IP68, OIML, Installation:** Adjustable leveling feet, designed for permanent or portable installations, 1,5m cable to connect digital indicator. **Approvals:** OIML class III , CE conform. **Power Supply:** 230 V mains, Power cord. **Options:** Back holder, Wall mounting for indicator, Indicator stand, Custom sizes and capacities

Standard indicator: **KPZ 52E91**, **For approved applications:** **KPZ 52E91**, **Options for indicators:** Multi range, RS 232 serial interface, Various printers connection, Radio data transfer, WLAN, etc.. Internal battery



















.....Special requirements for unique loading - please contact us for more information!

German design and own EU production guarantees high quality.



Stainless steel Material : DIN 1.4301 / 1.4541 / 1.4404 / IP 67/68 + IP 69K

Weighing range up to 300 kg



Typ	Kapazität	Teilung	Abm. /mm	Eichf.	Anzeige	Art.-Nr
KPZ 206N	6 kg	0,5g	250 x 300 x 120	No	KPZ 52E91/IP67	206N00062300
KPZ 2E06N	6 kg	2g	250 x 300 x 120	Yes 	KPZ 52E91/IP67	2E06N0006230
KPZ 206N	15 kg	1g	250 x 300 x 120	No	KPZ 52E91/IP67	206N00152300
KPZ 2E06N	15 kg	5g	250 x 300 x 120	Yes 	KPZ 52E91/IP67	2E06N0015230
KPZ 206N	30 kg	2g	250 x 300 x 120	No	KPZ 52E91/IP67	206N00302300
KPZ 2E06N	30 kg	10g	250 x 300 x 120	Yes 	KPZ 52E91/IP67	2E06N0030230
KPZ 206N	15 kg	1g	300 x 400 x 150	No	KPZ 52E91/IP67	206N00153400
KPZ 2E06N	15 kg	5g	300 x 400 x 150	Yes 	KPZ 52E91/IP67	2E06N0015340
KPZ 206N	30 kg	2g	300 x 400 x 150	No	KPZ 52E91/IP67	206N00303400
KPZ 2E06N	30 kg	10g	300 x 400 x 150	Yes 	KPZ 52E91/IP67	2E06N0030340
KPZ 206N	75 kg	5g	300 x 400 x 150	No	KPZ 52E91/IP67	206N00753400
KPZ 2E06N	60 kg	20g	300 x 400 x 150	Yes 	KPZ 52E91/IP67	2E06N0060340
KPZ 206N	30 kg	2g	420 x 520 x 150	No	KPZ 52E91/IP67	206N00304500
KPZ 2E06N	30 kg	10g	420 x 520 x 150	Yes 	KPZ 52E91/IP67	2E06N0030450
KPZ 206N	75kg	5g	420 x 520 x 150	No	KPZ 52E91/IP67	206N00754500
KPZ 2E06N	60kg	20g	420 x 520 x 150	Yes 	KPZ 52E91/IP67	2E06N0060450
KPZ 206N	150 kg	10g	420 x 520 x 150	No	KPZ 52E91/IP67	206N01504500
KPZ 2E06N	150 kg	50g	420 x 520 x 150	Yes 	KPZ 52E91/IP67	2E06N0150450
KPZ 206N	30/75	2/5g	460 x 600 x 150	No	KPZ 52E91/IP67	206NM0604600
KPZ 2E06N	30/60	10/20g	460 x 600 x 150	Yes 	KPZ 52E91/IP67	2E06NM060460
KPZ 206N	60/150	5/10g	460 x 600 x 150	No	KPZ 52E91/IP67	206NM1504600
KPZ 2E06N	60/150	20/50g	460 x 600 x 150	Yes 	KPZ 52E91/IP67	2E06NM150460
KPZ 206N	150/300	10/20g	460 x 600 x 150	No	KPZ 52E91/IP67	206NM3004600
KPZ 2E06N	150/300	50/100g	460 x 600 x 150	Yes 	KPZ 52E91/IP67	2E06NM300460
KPZ 206N	75 kg	5g	600 x 600 x 150	No	KPZ 52E91/IP67	206N00756600
KPZ 2E06N	60 kg	20g	600 x 600 x 150	Yes 	KPZ 52E91/IP67	2E06N0060660
KPZ 206N	150 kg	10g	600 x 600 x 150	No	KPZ 52E91/IP67	206N01506600
KPZ 2E06N	150 kg	50g	600 x 600 x 150	Yes 	KPZ 52E91/IP67	2E06N0150660
KPZ 206N	300 kg	20g	600 x 600 x 150	No	KPZ 52E91/IP67	206N03006600
KPZ 2E06N	300 kg	100g	600 x 600 x 150	Yes 	KPZ 52E91/IP67	2E06N0300660
KPZ 206N	75 kg	5g	600 x 800 x 150	No	KPZ 52E91/IP67	206N00756800
KPZ 2E06N	60 kg	20g	600 x 800 x 150	Yes 	KPZ 52E91/IP67	2E06N0060680
KPZ 206N	150 kg	10g	600 x 800 x 150	No	KPZ 52E91/IP67	206N01506800
KPZ 2E06N	150 kg	50g	600 x 800 x 150	Yes 	KPZ 52E91/IP67	2E06N0150680
KPZ 206N	300 kg	20g	600 x 800 x 150	No	KPZ 52E91/IP67	206N03006800
KPZ 2E06N	300 kg	100g	600 x 800 x 150	Yes 	KPZ 52E91/IP67	2E06N0300680

KPZ price includes complete scale with indicator

Typ	Capacity	Div.	Dimm.mm.	Approval possibility	Indicator	€/pcs	Art.-No
KPZ 2E-06-5	6 kg	0,2 g	260 x 300	No	KPZ 52E91/IP67		2065000623
KPZ 2E-06-5	6 kg	2,0 g	260 x 300	Yes 	KPZ 52E91/IP67		2E065000623
KPZ 2E-06-5	15 kg	0,5 g	260 x 300	No	KPZ 52E91/IP67		2065001523
KPZ 2E-06-5	15 kg	5,0 g	260 x 300	Yes 	KPZ 52E91/IP67		2E065001523
KPZ 2E-06-5	30 kg	1,0 g	260 x 300	No	KPZ 52E91/IP67		2065003023
KPZ 2E-06-5	30 kg	10 g	260 x 300	Yes 	KPZ 52E91/IP67		2E065003023



Indicator KPZ 52E-9-1, Stainless steel housing IP 67, 6 digit 25 mm high LCD-Display, with backlight function, large function keys

Pre-set / limit value control, Simple piece counting

EC approved class  up to 10.000 e



KPZ 2E06N IP 69K / Bench Scale

Stainless steel, DIN 1.4301 / IP 69K

KPZ 2E06NK / Bench Scale complet Stainless steel, DIN 1.4301 / IP 69K

Construction: Robust, maintenance-free, welded stainless steel construction, heavy duty design, for food and other industrial use, Robust Stainless steel weighing platform, Maintenance-free durable Stainless steel (DIN 1.4301 / IP/69K, Stainless Steel Load cell IP 69K. **Approvals:** OIML class III , CE conform. Indicator Type KPZ 51E-45K

Typ	Capacity kg	Div.	Dimm.mm.	Approval possibility	Indicator	Art.-No
KPZ 206N45K	6	0,5g	250 x 300 x 120	No	KPZ 51E-45K.IP69K	206NKM006230
KPZ 2E06N45K	6	2g	250 x 300 x 120	Yes	KPZ 51E-45K.IP69K	2E06NKM00623
KPZ 206N45K	15/30	1/2g	250 x 300 x 120	No	KPZ 51E-45K.IP69K	206NKM015230
KPZ 2E06N45K	15/30	5/10g	250 x 300 x 120	Yes	KPZ 51E-45K.IP69K	2E06NKM01523
KPZ 206N45K	6/15	0,5/1g	300 x 400 x 150	No	KPZ 51E-45K.IP69K	206NKM015340
KPZ 2E06N45K	6/15	2/5g	300 x 400 x 150	Yes	KPZ 51E-45K.IP69K	2E06NKM01534
KPZ 206N45K	15/30	1/2g	300 x 400 x 150	No	KPZ 51E-45K.IP69K	206NKM030340
KPZ 2E06N45K	15/30	5/10g	300 x 400 x 150	Yes	KPZ 51E-45K.IP69K	2E06NKM03034
KPZ 206N45K	30/75	2/5g	300 x 400 x 150	No	KPZ 51E-45K.IP69K	206NKM075340
KPZ 2E06N45K	30/60	10/20g	300 x 400 x 150	Yes	KPZ 51E-45K.IP69K	2E06NKM06034
KPZ 206N45K	15/30	1/2g	420 x 520 x 150	No	KPZ 51E-45K.IP69K	206NKM030450
KPZ 2E06N45K	15/30	5/10g	420 x 520 x 150	Yes	KPZ 51E-45K.IP69K	2E06NKM03045
KPZ 206N45K	30/75	2/5g	420 x 520 x 150	No	KPZ 51E-45K.IP69K	206NKM075450
KPZ 2E06N45K	30/60	10/20g	420 x 520 x 150	Yes	KPZ 51E-45K.IP69K	2E06NKM075450
KPZ 206N45K	60/150	5/10g	420 x 520 x 150	No	KPZ 51E-45K.IP69K	206NKM150450
KPZ 2E06N45K	60/150	20/50g	420 x 520 x 150	Yes	KPZ 51E-45K.IP69K	2E06NKM15045
KPZ 206N	30/75	2/5g	460x600x150	No	KPZ 51E-45K.IP69K	206NKM075460
KPZ 2E06N	30/60	10/20g	460x600x150	Yes	KPZ 51E-45K.IP69K	2E06NKM06046
KPZ 206N	60/150	5/10g	460x600x150	No	KPZ 51E-45K.IP69K	206NKM150460
KPZ 2E06N	60/150	20/50g	460x600x150	Yes	KPZ 51E-45K.IP69K	2E06NKM15046
KPZ 206N	150/300	10/20g	460x600x150	No	KPZ 51E-45K.IP69K	206NKM300460
KPZ 2E06N	150/300	50/100g	460x600x150	Yes	KPZ 51E-45K.IP69K	2E06NKM30046
KPZ 206N45K	30/75	2/5g	600 x 600 x 150	No	KPZ 51E-45K.IP69K	206NKM075660
KPZ 2E06N45K	30/60	10/20g	600 x 600 x 150	Yes	KPZ 51E-45K.IP69K	2E06NKM06066
KPZ 206N45K	60/150	5/10g	600 x 600 x 150	No	KPZ 51E-45K.IP69K	206NKM150660
KPZ 2E06N45K	60/150	20/50g	600 x 600 x 150	Yes	KPZ 51E-45K.IP69K	2E06NKM15066
KPZ 206N45K	150/300	10/20g	600 x 600 x 150	No	KPZ 51E-45K.IP69K	206NKM300660
KPZ 2E06N45K	150/300	50/100g	600 x 600 x 150	Yes	KPZ 51E-45K.IP69K	2E06NKM30066
KPZ 206N45K	30/75	2/5g	600 x 800 x 150	No	KPZ 51E-45K.IP69K	206NKM075680
KPZ 2E06N45K	30/60	10/20g	600 x 800 x 150	Yes	KPZ 51E-45K.IP69K	2E06NKM06068
KPZ 206N45K	60/150	5/10g	600 x 800 x 150	No	KPZ 51E-45K.IP69K	206NKM150680
KPZ 2E06N45K	60/150	20/50g	600 x 800 x 150	Yes	KPZ 51E-45K.IP69K	2E06NKM15068
KPZ 206N45K	150/300	10/20g	600 x 800 x 150	No	KPZ 51E-45K.IP69K	206NKM300680
KPZ 206N45K	150/300	50/100g	600 x 800 x 150	Yes	KPZ 51E-45K.IP69K	206NKM300680



KPZ 51E-45K, IP 69 K

- Special construction:
- extra flat design
 - including roller conveyor
 - open hygienic and easy to clean construction



German design and own EU production guarantees high quality.
Stainless steel Material : DIN 1.4301 / 1.4541 / 1.4404 / IP 67/68 + IP 69K



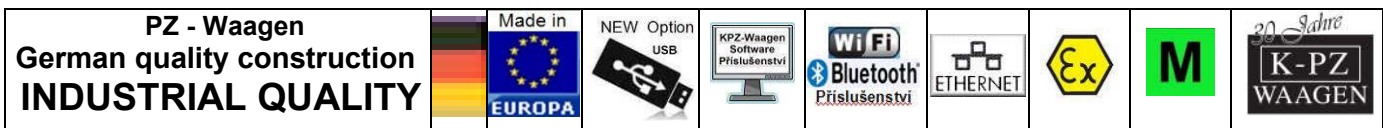

200305 00 N UK €

Options for the KPZ floor scales (stainless steel construction, material 1.4301)

Options / accessories / extra charge		Article-No.
<i>Indicators: Options (extra cost)</i>		
Delivery without Indicator KPZ 52E-9-1	REDUCED PRICE	12N52E91OHNE
Printers: Options (extra cost) + costs for output RS 232		
Roller printer FAVORIT Plus, for KPZ 52(E)-*,		120024000000
Label printer and code printer type DR 2 for KPZ 56E-3, KPZ 51E-9-2		120038000000
Print design for DR 2 on request		204333100000
Printer Info and Printout Example Starts from Page 142		

<i>serial interface / Setpoints: Options / extra costs</i>		
Serial interface RS232 C for KPZ 52E-9-1		123071000000
Serial interface RS232 C for KPZ 51E-9-2		123072000000
Setpoints, 3 pcs for KPZ 51E-9-2 (more – OK – less)		120029002000
Software "KPZ Smart Scale" STANDARD (incl. RS232 serial interface)		5S0001000000
Software "KPZ Smart Scale" PROFESSIONAL (incl. RS232 serial interface)		5S0005000000
Software "KPZ Smart Scale" PREMIUM (incl. RS232 serial interface)		5S0010000000
Wi-Fi Datatransfer		120005000000
Rechargeable battery version KPZ 52E-9-1, 51E-9-2		120040000000

<i>construction accessories (extra charge)</i>		
Indicator stand for KPZ 52(E)-9-1, Stainless Steel		1S0210000000
Wall mounting indicator KPZ 52E91		1S0020000000
Cable Protection against mouse bite		
longer cables		
Smooth surface weighing plates surface		
Fixing plates for the load cell feets (Set of 4 pcs.)		
Stronger weighing plate for higher point load		
Special overload protection at high load		
screwed weighing plate		
Weighing plate to open		

Factoryfirst certification (extra charge)	€/pcs	Artikel-Nr.
For Capacity from 0 kg to 21 kg		300PL0000020
For Capacity from 21 kg bis 200 kg		300PL0000200
For Capacity from 201 kg bis 500 kg		300PL0000500
For Capacity from 501 kg bis 3.000 kg		300PL0003000
For Capacity from 3.000 kg bis 10.000 kg		300PL0010000
For Capacity from 21 kg bis 200 kg Double range		300PLM000200
For Capacity from 201 kg bis 500 kg Double range		300PLM000500
For Capacity from .501 kg bis 3.000 kg Double range		300PLM003000
For Capacity from 3.000 kg bis 10.000 kg Double range		300PLM010000

... please contact us for special requests!

German design and own EU production guarantees high quality.

Stainless steel Material : DIN 1.4301 / 1.4541 / 1.4404 / IP 67/68 + IP 69K

Special models are our speciality!



KPZ 2E-07-2N / Wall folding scale
Stainless steel DIN 1.4301 IP 67/68 + IP 69K



IP 69 K



KPZ 52E91, IP 67

Solid and stable platform scales series **KPZ 2E06N**. **German design and own EU production guarantees high quality**. Designed as Bench scales, for **Food industrial weighing**. High accuracy. Maintenance-free durable **Stainless steel, DIN 1.4301 / IP67/68 / IP69K** construction. High quality polishing Standard.

Construction serial interface, Various printers connection, Radio data transfer,; Robust, maintenance-free, welded stainless steel construction, heavy duty design for **food industrial use**, **Stainless steel** weighing platform, Maintenance-free durable **Stainless steel (DIN 1.4301 / IP67/68 / IP69K, Load cells: Robust, stainless steel load cell, IP68, OIML, Approvals: OIML class III** , CE conform, **Power Supply: 230 V mains, Power cord.**

Options: Back holder, Wall mounting for indicator, Indicator stand, Custom sizes and capacities

Standard indicator: **KPZ 52E91, For approved applications: KPZ 52E91, Options for WLAN, etc..**

Internal battery.indicators: Multi range, RS 232

Typ	Capacity	Div.	Dimm.mm.	Approval possibility	Indicator	Art.-No
2E072N	60 kg	20g	480 x 490 mm	Yes	KPZ 52E91/IP67	2E072N0060
2E072N	75 kg	5g	480 x 490 mm	No	KPZ 52E91/IP67	2072N00075
2E072N	150 kg	50g	480 x 490 mm	Yes	KPZ 52E91/IP67	2E072N0150
2E072N	150 kg	10g	480 x 490 mm	No	KPZ 52E91/IP67	2072N00150

Hanging construction, 1 hook		2E0720151001
Hanging construction, 2 hook		2E0720151002

KPZ price includes complete scale with indicator.



Option : Hanging construction (gallows) for KPZ 2E (072) with 1 or 2 hook

... please contact us for special requests!

German design and own EU production guarantees high quality.

Stainless steel Material : DIN 1.4301 / 1.4541 / 1.4404 / IP 67/68 + IP 69K



KPZ 2NL Overhead Rail Scales

Stainless steel DIN 1.4301 IP 67/68 + IP 69K

Various weighing ranges and weighing rail lengths are available.

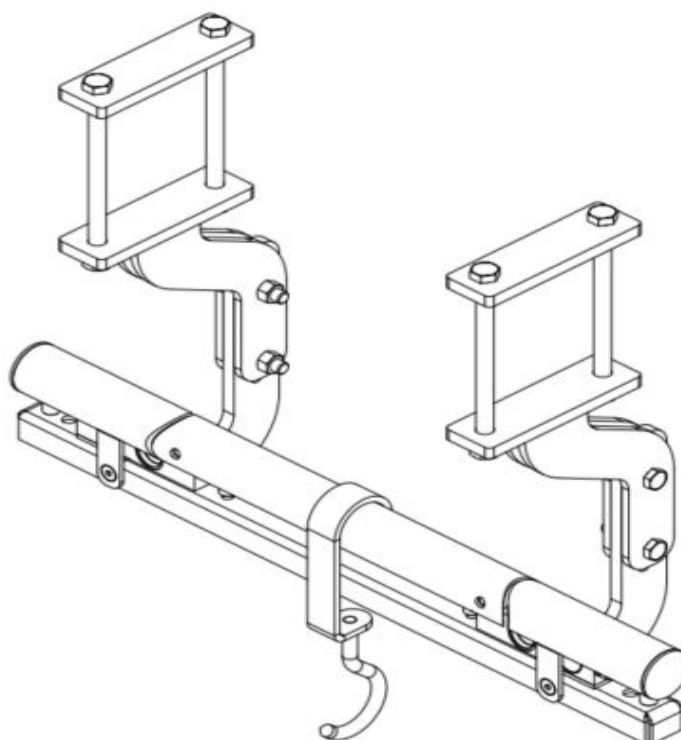

Monorail weighing saves time in meat processing settings



Strain gauge weighing cells weigh 150 kg or 300 kg capacities and offer rail lengths of 200, 300 or 400 mm—ideal for weighing animal carcasses. DSO monorail scales can be easily installed above the mounting support regardless of the type of rail system used, as both versions have a rail- insert support and universal adaption plate. These analog overhead rail scales can be operated with a certifiable resolution of 50 g for a weighing capacity of 150 kg and 100 g for a weighing capacity of 300 kg.

.....pls contact us for special request !

German design and own EU production guarantees high quality.

Stainless steel Material : DIN 1.4301 / 1.4541 / 1.4404 / IP 67/68 + IP 69K



KPZ 71-7N / hand pallet truck with integrated scale  
stainless steel DIN 1.4301 / IP67/68+ IP 69K

Capacity 2.200 kg | Division : 100g , 200 g, 500g | accuracy: 0,02 %
the world highest accuracy in mobile scales

EU-approval class M 



weighing capacity up to **2.200 kg**
 25 mm LCD – digits
 backlight
 100 % tare
 easy readable



Long exploitation period thanks to lubrication grease nipples

Optionen:



Better quality !!! KPZ applies only EU approved components

Mobile Weighing! = Saved working hours !

German design and own EU production guarantees high quality.

EU-approval class M 

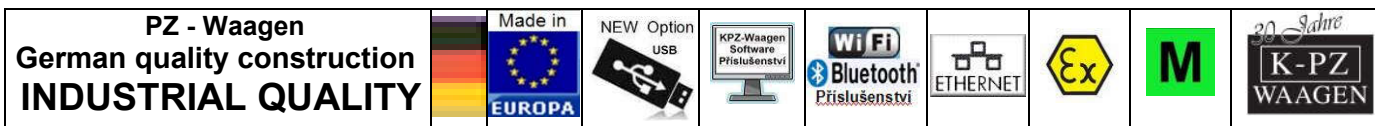

200305 00 N UK €

Solid and stable platform scales series [KPZ 71-7N](#). **German design and own EU production guarantees high quality.** Designed as floor scales, for food and Chemical industrial weighing. High accuracy. Maintenance-free durable Stainless steel (DIN 1.4301 / IP67/68 / 69K) construction. High quality polishing standard.

Construction: Robust, maintenance-free, welded steel construction, heavy duty design for food industrial use, **Stainless steel** weighing platform, Maintenance-free durable Stainless steel (DIN 1.4301 / IP67/68 / IP 69K

Load cells: Robust, **stainless steel load cell**, IP68, OIML, with a high overload capacity. **Installation:** Adjustable leveling feet, designed for permanent or portable installations, 5m cable to connect digital indicator.



Options: Custom sizes and capacities

Standard indicator: [KPZ 52E91](#), **For approved applications:** [KPZ 52E91](#), **Options for indicators:** Multi range, RS 232 serial interface, Various printers connection, Radio data transfer, WLAN, etc.. Internal battery

Approvals: OIML class III , CE conform. **Power Supply** : 230 V mains, Power cord.

Construction: complete stainless steel version of KPZ 71-7. High quality flat iron construction just constructed for weighing technic. steering wheels: Nylon (Ø 200mm) fork wheels: Tandem Nylon. weighingsystem: 4 high grad, stainless steel loadcells, Type KPZ 502E-3, IP68, EU approval certification class III, accuracy: 0,02%, power supply: Accu, charger incl. Certification: EC approval possibility class III, Declaration of conformity, approved version.

hand pallet weigher KPZ 71-7N stainless steel [Material 1.4301](#)

Typ	Fork Dim. mm	capacity kg	Div. g	Approval possible	Indicator	Article – No.
KPZ 71-7N,	560x1150	2200	500	No	KPZ 52E91/IP67	717N00002200
KPZ 71-7NM,	560x1150	1500/2200	200/500	No	KPZ 52E91/IP67	717NM00002200
KPZ 71-7N,	560x1150	1500	200	No	KPZ 52E91/IP67	717NM00001500
KPZ 71-7N,	560x1150	2.500	200	No	KPZ 52E91/IP67	717N000001500
KPZ 71E-7N	690x1150	2.200 kg	500 g	No	KPZ 52E91/IP67	717N07002200
KPZ 71E-7N,	560x1150	600	200g	YES 	KPZ 52E91/IP67	717N0000060E
KPZ 71E-7NM,	560x1150	1500	500g	YES 	KPZ 52E91/IP67	717NM0000150E
KPZ 71E-7N,	560x1150	1.500/2200	500/1000g	YES 	KPZ 52E91/IP67	717NM0000220E
KPZ 71E-7N,	560x1150	2200	1000g	YES 	KPZ 52E91/IP67	717N0000220E
KPZ 71E-7N	690x1150	2.200 kg	1000 g	YES 	KPZ 52E91/IP67	717N0700220E

Option : Fork high 75 mm or 51 mm

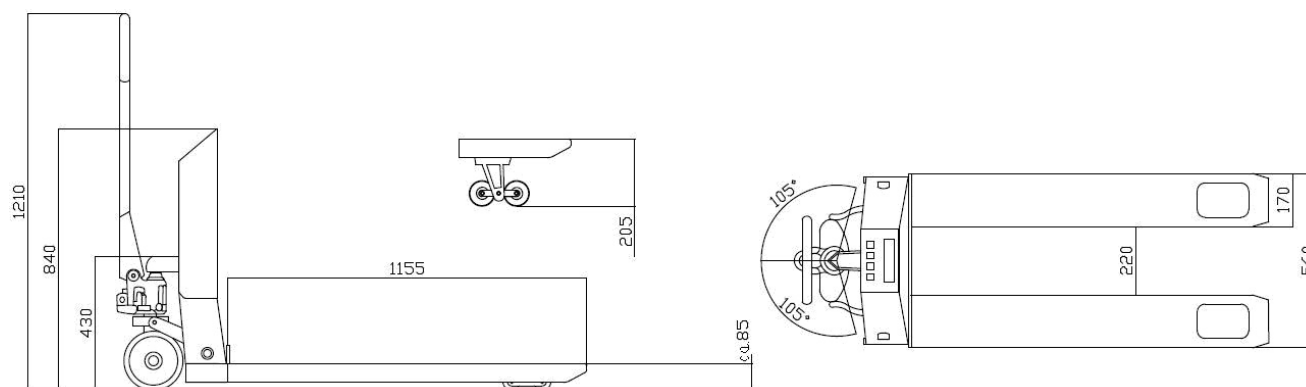

own weight approx. 150 kg.

Stainless steel DIN 1.4301 / 1.4541 / 1.4404 and IP 67/68 + IP 69K version possible

Options? Ask us, we do almost everything possible for you

German design and own EU production guarantees high quality.



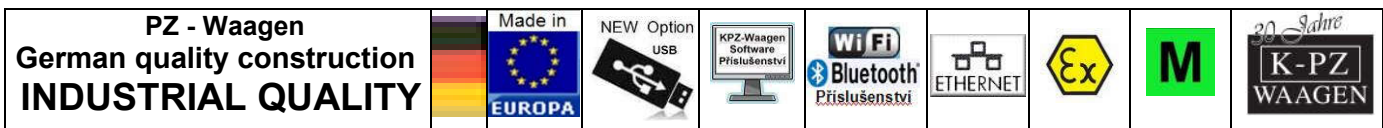

200305 00 N UK €

Options / accessories / extra charge	Article-No.
Printers: Options (extra cost) + costs for output RS 232	
Roller printer FAVORIT Plus, for KPZ 52(E)-*,	120024000000
Label printer and code printer type DR 2 for KPZ 56E-3, KPZ 51E-9-2	120038000000
Print design for DR 2 on request	204333100000
Printer Info and Printout Example Starts from Page 142	

serial interface / Setpoints: Options / extra costs	Article-No.
Serial interface RS232 C for KPZ 52E-9-1	123071000000
Serial interface RS232 C for KPZ 51E-9-2	123072000000
Setpoints, 3 pcs for KPZ 51E-9-2 (more – OK – less)	120029002000
Software "KPZ Smart Scale" STANDARD (incl. RS232 serial interface)	5S0001000000
Software "KPZ Smart Scale" PROFESSIONAL (incl. RS232 serial interface)	5S0005000000
Software "KPZ Smart Scale" PREMIUM (incl. RS232 serial interface)	5S0010000000
Wi-Fi Datatransfer	120005000000
Rechargeable battery version KPZ 52E-9-1, 51E-9-2	120040000000

construction accessories (extra charge)	Article-No.
Indicator stand for KPZ 52(E)-9-1, Stainless Steel	1S0210000000
Wall mounting indicator KPZ 52E91	1S0020000000
Cable Protection against mouse bite	
longer cables	
Smooth surface weighing plates surface	
Fixing plates for the load cell feet (Set of 4 pcs.)	
Stronger weighing plate for higher point load	
Special overload protection at high load	
screwed weighing plate	
Weighing plate to open	

Factoryfirst certification (extra charge)	€/pcs	Artikel-Nr.
For Capacity from 0 kg to 21 kg		300PL0000020
For Capacity from 21 kg bis 200 kg		300PL0000200
For Capacity from 201 kg bis 500 kg		300PL0000500
For Capacity from 501 kg bis 3.000 kg		300PL0003000
For Capacity from 3.000 kg bis 10.000 kg		300PL0010000
For Capacity from 21 kg bis 200 kg Double range		300PLM000200
For Capacity from 201 kg bis 500 kg Double range		300PLM000500
For Capacity from .501 kg bis 3.000 kg Double range		300PLM003000
For Capacity from 3.000 kg bis 10.000 kg Double range		300PLM010000

... please contact us for special requests!

Stainless steel DIN 1.4301 / 1.4541 / 1.4404 and IP 67/68 + IP 69K version possible

German design and own EU production guarantees high quality.

Special models are our speciality!



KPZ Indicators

 <p>KPZ 52E-7</p> <p>Klasse III M</p>	 <p>KPZ 52E-7/1</p> <p>Klasse III M</p>	 <p>KPZ 56E-4</p> <p>Klasse III M</p>
 <p>KPZ 52E-9-1</p> <p>Klasse III M</p>	 <p>KPZ 51E-9-2</p> <p>Klasse III M</p>	 <p>KPZ 51E11 - 13</p>
 <p>KPZ 58-2</p> <p>Klasse III M</p>	 <p>KPZ 52-19</p>	 <p>Big display/second display</p>
 <p>KPZ 54E-*</p> <p>Klasse III M</p>	 <p>KPZ 54E-*</p> <p>Klasse III M</p>	

We reserve the right to make technical modifications and price changes without prior notification

KPZ Indikátory

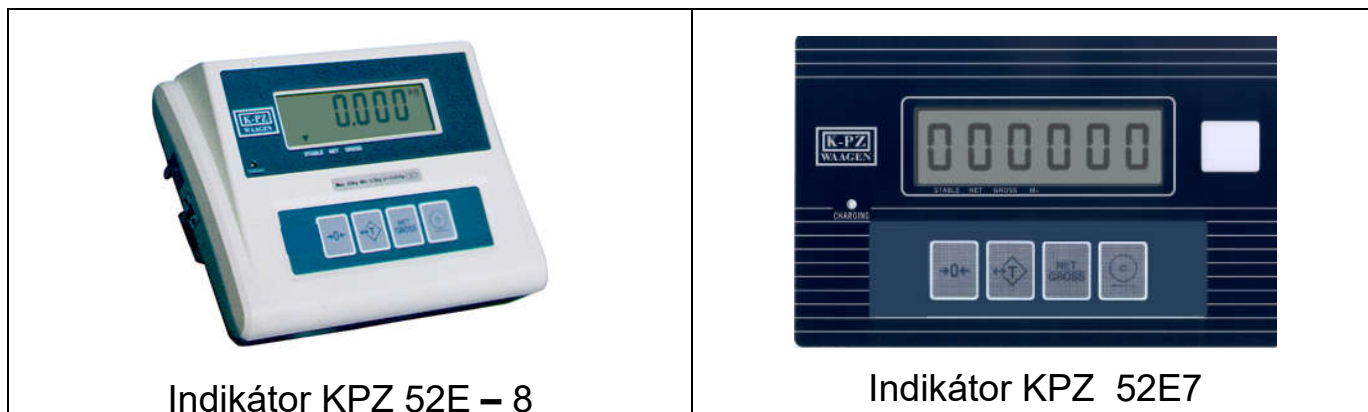

Klasse



Multirange division : See technical data of the scale. OIML Class



Description KPZ 52(E) - 7

Robust external case made from ABS incorporating a water-proof front keypad with large function keys. 6-digit, 26 mm high LCD – Display with back-light function providing a clear and easily readable weight indication. Operating temperature – 10 to + 40 °C. 230 Volt-operation.

Function : automatic and manual Zero setting. Tare setting up to 100 %, switch Net and gross weight repeatedly. Optional RS 232 Data output and addition sum printing, minus indication, LCD back-light (3 settings), audible/visible alarm/check HIGH-OK-LOW (That means two available value of weight), automatic selftest, Error message on display.

LED indication for : Zero, Tare weight, stabile, LOW Bat, power, addition memory.





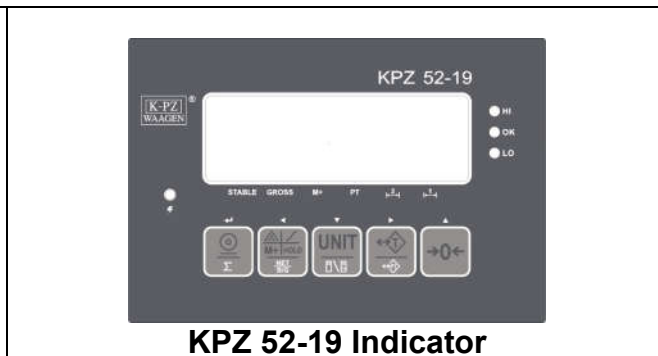

Options: Configurable RS 232 output, data output (different formats), Roller printer, label printer, set point (High-OK-Low),

Key	Description
ON/OFF	This key is installed on the ABS housing. This key is used to switch the indicator ON or OFF. When activated the display shows the $\rightarrow 0 \leftarrow$ signal is on.
$\rightarrow 0 \leftarrow$	If the LCD Display is not indicating 0.00 , press this key to re-zero the scale. The display indicates that the ZERO signal is now on. The unit can zero $\pm 2\%$ of the max. capacity. Using this switch do not change the range of maximal capacity.
$\leftrightarrow T$	This key is used to carry out tare and zero settings, when an existing weight is on the scale. If a TARE weight is stored, the Tare Signal will indicate over Net . As soon as you remove the TARE weight re-set to ZERO by the user of the scale, the display shows the weight with a minus symbol in front on the LCD display. The maximum weighing range is reduced for the tare value. Tare capability is 100% of the scale capacity, and can be used repeatedly. Multiple tare is possible. Negative weight values can be moved to 0.00 .
NET GROSS	This key is used to switch between net and gross weight repeatedly. The display indicate Net or τ GROSS. This $\frac{NET}{GROSS}$ key can be used only when the scale is in the tare mode. By showing the Gross value (τ GROSS) the other keys are closed.
	If a printer interface is installed, this key will print out (printer version) or transfer the weight data being displayed . The weight value is stored in the data logger. The display indicate τ M+ .To print the grand total of all printed weights the weight must be removed. The display shows $\rightarrow 0 \leftarrow$. Then press the  key twice the total sum of the weighing results will be printed .

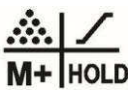
KPZ Indicators



Robust external case including a water-proof front keypad with large function keys. 6-digit, 30 mm high LCD – Display with blue back-light function providing a clear and easily readable weight indication. Operating temperature – 10 to + 40 °C. 230 Volt-operation. Battery operation possible. **Function** : automatic and manual Zero setting. Tare setting up to 100 %, pretare function, switch Net and gross weight repeatedly. Optional RS 232 Data output and addition sum printing, minus indication, HIGH-OK-LOW function, totalizing function, automatic selftest, Error message on display. **LED indication for** : Zero, Tare weight, stable, LOW Bat, HI LOW OK .
Options: RS 232 output, data output, Roller printer,

Key	Function	Hold for 1 sec.
	Printout / data output (Option)	Communication settings
Σ	Totalizing	
	Modus selection / Function	
	Switching between net and gross weight (net mode)	
UNIT	switching units	
	Switch between weight / unit weight (piece counting mode)	
	Tare	1. Backlight 2. Switch on zero setting 3. Gravitation value
	Pretare	
	Zero	battery voltage



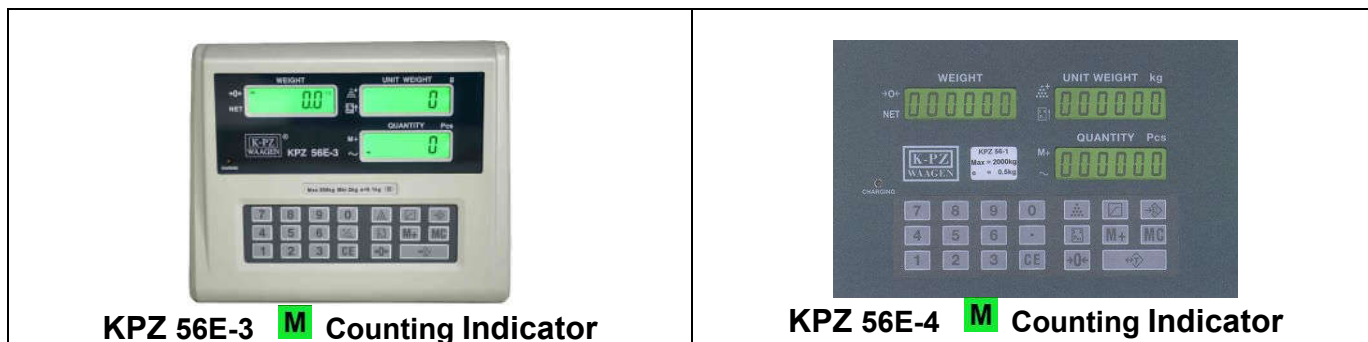

KPZ Indicators



Optimal unit weight for the piece count: 1/5 of the scale division.

This high-quality Parts Counting Indicator can be used in all types of uncertified and for trade weighing applications. Due to the high external resolution and the 20x expanded internal resolution, the unit is ideally suitable for both small and large item component counting. The expanded internal resolution of the indicator provides clear signal stability and repeatability. The 3 window highly visible LCD-Display provides the operator with clear data information. Additionally, with the robust construction of a steel housing, built-in rechargeable battery, and the simple to operate dust and waterproof front keypad, makes this part counting indicator a valuable tool for all industrial weighing & counting applications.

Description of Keypad

0 to 9 and .	Use to enter piece weight, total quantity or Tare value.
CE:	Deletes all value entered via the keypad.
→0←	1) Use this key to Zero the scale 2) Use this key by pressing twice to enter backlight options (see Backlight Function)
	Use this key to Tare the scale
	Use this key to confirm entered quantity.
	Use this key to confirm entered piece weight.
	Use this key to pre-set upper count limit, when the value is achieved an audible signal will be emitted.
	Use this key to save a piece weight in memory.
M+	Count accumulation key.
MC	Deletes all accumulation count in memory.

Standard features : Indicator: Display indication 1/30.000, internal divisions 1/600.000. Built-in calibration routine. Automatic & manual zero setting. 100% Tare. Piece Counting. The tare value and the piece weight can be weighed or entered via the front keyboard. The indicator has a 10 piece weight memory. 3 window LCD display with back-lighting option showing weight, quantity and individual piece weight. Counting accumulation. Audible peak alarm for Multi counting applications. Symbol indication shown at display for : Power re-charging control, LO-BAT. Zero, Tare, Stable, Memory, Piece number, Piece weight.

Options :

Factory configured serial interface (RS 232). With this interface in addition to date, weight & count information, two additional 15 character line entries can be included (for example Item number, operator number etc.) Printing from this interface via a single tally roll printer or label printer which will print all data in a numerical format, or in a range of standard **Barcodes**.

KPZ Indicators

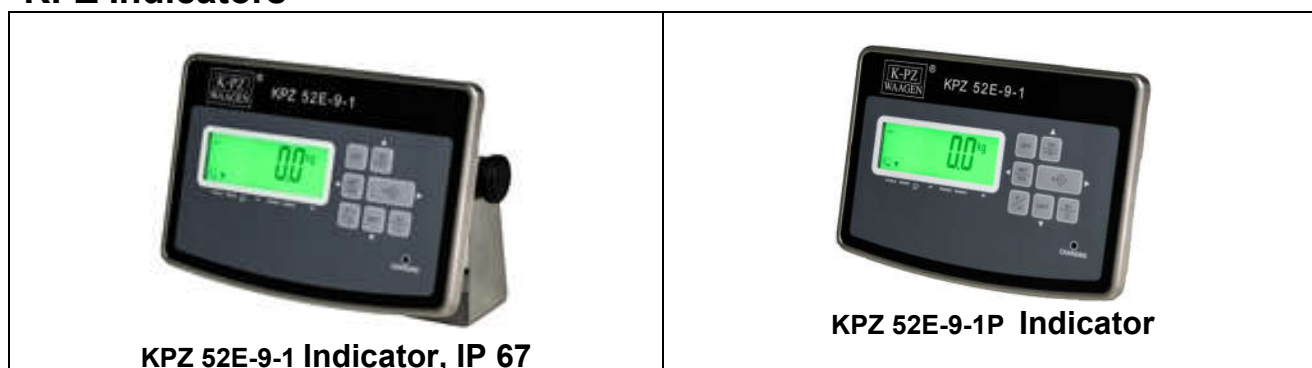

OIML trade approved Class III **M**, 10.000 e

Technical data: Indicator: **KPZ 52E-9-1** robust, stainless steel housing **IP 67**, user-friendly, large function keys. LCD display: 6 digit, various symbols, backlight, high of digits 25 mm. Operating temperature from -10°C up to $+40^{\circ}\text{C}$, operation 230 Volt through external power supply, inbuilt battery (possibility of battery operation).

Functions: automatic and manual zero setting, switch Net/Gross weight, 100% tare, multiple tare, unit switching, simple piece counting by reference no. 10, 20, 50, 100 i 200. Possibility to enter data and bring out data through serial interface (optional): computer functional control, possibility of choosing different exit formats, **printout in simple format**, edition activation: via computer, continuously or after zero come back. Minus indication, LCD backlight, automatic shut off after 0-9 minutes, pre-set value control or limit value control LOW – OK - HIGH (any two weight values to choose, tone or light signal), electronic stabilization filter and signal distortion, automatic self test, error messages.

Indication: zero setting, gross, net, stability, LOW-Bat indication, pre-set/limit value, too small piece quantity or too small weight. **LED:** charging status. **Options:** serial interface RS 232, battery, label printer

Key functions:

Key	Description
ON	<i>switch the indicator ON</i>
→0←	<i>Switch the indicating to 0.00</i>
OFF	<i>switch the indicator OFF</i>
↔T	<i>TARE function</i>
NET GROSS	<i>Switch over Net / Gross Tare, repeatedly</i>
UNITS	<i>Switch over weighing units</i>
F/HR	<i>In approval version: High resolution indication (5 sec)</i>
M+	<i>Totalizing and printout/ data output</i>

Robust external case including a water-proof front keypad with large function keys. 6-digit, 30 mm high LCD – Display with blue back-light function providing a clear and easily readable weight indication. Operating



IP 67,

10 Setpoint memory
Tare setting by key,
Zero setting,
Alarm / check control setting,
back light LCD-Indicator,
Addition sum memory,
Multi range division,

OIML Class  **M** 10.000 e

Keypad :



Rear view and Dimension:

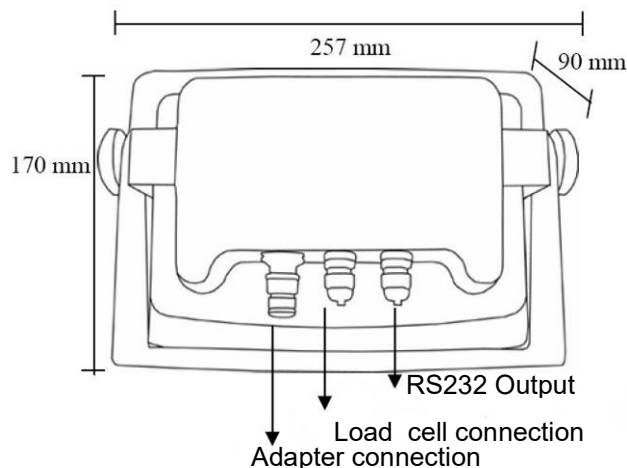

(For IP 67 use only cable diameter from 3 to 5,5mm)

Short description KPZ 51 E – 9 – 2 :

Case:

Compact, robust, high-quality stainless steel case **IP 67.** with hanger to the wall mounting or table mounting (optional stand possible), cable connecting by cable glands.

Indication and keyboard:

6-digit 25 mm high LCD – Display with back-light function providing a clear and easily readable weight indication, and a great, illuminated, coloured joist graphic display, membrane keypad with 16 buttons.

Symbol indication for : zero, tare, stable, LOW Bat, accumulator tension joist , check weighing HIGH-OK-LOW.

Basic functions:

automatic and manual Zero setting. Tare setting op to 100 %, Pretare, switch Net, tare and gross weight repeatedly. Target weight check tolerance with+(/), limit value control (limit = range of Low/Ok/High), 10 debit-/ limit value lofts. About parameter attitude: Percentage function, automatic switching off of backlight and electronics, interface functions and parameter.

Feature :

Multi range, selectable weighing unit, automatic zero correction, automatic shutoff 0-9 minutes, automatic. Backlight, digital stabilization and disturbance filters, measuring speed, gravitation zones, self-test function and error messages.

Energy:

internal accumulator, power supply unit of 230 VAC.

Certifications:

EU-calibrating admittance class  to 10,000 e.

Technical date:

Max . recommended external resolution 30,000 div, min . sensitiveness 0.3 µ V/d, supply voltage 5 VDC, zero input signal-1 to 5 mV, weight input signal-1 to 14 mV up to four 350 Ω load cells, linearity 0.01% F.S.,operating temperature-10 to +40° C. **ptions:** Configurable RS 232 output, data output (different formats), Roller printer, label printer, set point (High-OK-Low),

Extended functions and optional possibilities (surcharge):

Connection:

Serial interface RS232 bidirectional, data output format and mode choice, factory programmable format, date and time, relay exit for alarm/check points.

KPZ 54-* / Touch screen indicator



- Touch Operating System for user friendly and fastest operations.
- Multi-printer selectable
- Custom printout options,
- Multi -language support
- Report management.
- PC keyboard and Mouse can be connected
- Software upgrade option.
- 9999 products possible to store in memory.
- designed for multiple use, such as Weighing, Target, Counting, Check weighing and Recipe operations.
- 2xUSB port, 1xRS232, optional more ports possible
- 7' or 8' display possible
- Robust ABS or stainless steel housing possible
- Dual scale option (extra charge) possibility



KPZ 51E-45K

IP69K

AISI 304 stainless steel weight Indicator (dimensions: 206x286x108 mm) with 6 PG9 cable glands, **IP69K protection rating**, stainless steel adjustable bracket included (overall dimensions with bracket: 206x290x187 mm). Optionals: panel / desk / column mounting. Six-key membrane keyboard with buzzer. Real-time clock with buffer battery.

Weight reading by another instrument via serial port.

Two serial ports (RS232 and RS485) for connection to:

- PC/PLC up to 32 instruments (max 99 with line repeaters) by ASCII protocol or ModBus RTU.
- Remote display.
- Printer.
- Optional integrated output: Profibus DP, DeviceNet, CANopen, Profinet IO, Ethernet/IP, Ethernet TCP/IP, Modbus/TCP.

Main functions:

- 5 setpoints (4 setpoints if Analog Output is present) configurable as normally open or normally closed. The operator can decide the setpoints activation for the net weight value, gross weight value, otherwise for positive weights or for positive and negative weights.
- Counting.
- Totalizing.
- Setting of hysteresis value for each setpoint.
- 12 groups selection by 5 setpoint from selector switch or contacts (EC/E options).
- Peak holder displaying by closing the Peak contact.
- Net/Gross function by keyboard or external contact.
- Manual adjustment of zero value in case of zero-setting not possible.
- Auto zero function.
- Auto zero-tracking function.
- Print of the weight via keyboard or external contact with date and time.

Operation: The inputs can work as: net/gross weight, zero-setting, peak, print or can be remotely read via protocol.

The outputs can work as setpoints or can be remotely switched via protocol.

Weight transmitter approved OIML R61 (Automatic Gravimetric Filling Instruments) according to WELMEC Guide 8.8:2011 (MID).

approvable EN45501-2014/31/UE-OIML R76:2006

- Maximum number of verification scale intervals n=10000
- Minimum input-voltage per VSI 0.2 µV
- Weighing range single range or multi range (max 3) or multi interval (max 3)
- Calibration via keyboard is protected through seals for the access to a setting jumper or installer password
- Semi-automatic zero and tare, predetermined tare functions.
- Weight subdivisions displaying (1/10 e)
- The following values can be printed from external contact: net/gross weight; tare; predetermined tare; date; time; ID code (if alibi memory is present)



KPZ 51E-41 indicator

Characteristics:

Software: Base

- Zeroing
- Tare
- Hand tare
- Gross / Net switching
- simple piece counting
- Add function
- automatic zeroing function

Function (Optional):

- Print function including date and time, external button
- I / O inputs as net / gross switching, zeroing, peak value, printout
- I / O outputs as set point function
- Communication protocol via serial interface
- 5 set points (4 set points if analogue output is available) Configurable as open or normally closed. The set points can be set as net weight, gross weight, for positive or for positive and negative weights.
- Setting the hysteresis value for each set point.

Option (extra charge):

- Wall mounting
- Stand
- Battery
- Alibi memory
- Analog output
- I/O's, relay output
- Printer
- Serial interface RS232 and RS485
- Remote display
- Profibus, Ethernet TCP/IP, Modbus, CANopen, DeviceNet.

Power supply:

- Mains 110-240VAC, 3m long cable

Technical Data:

- LCD display, backlit (6 digit 20mm high, semi alphanumeric)
- 16 icon displays
- Robust ABS housing IP67
- Temperature range: -10 ° C to 40 ° C
- dim. 122x226x164mm
- EU type approval Class III to 10,000e

Big display (second display), can be combined with all KPZ Indicator

Model : KPZ GD 1-1

150057052000 Large display KPZ GD1-1, 6-digit, 127 mm LED dot matrix, with 5m connection cable and interface for connection to the display KPZ 52 (E) - *

Model : KPZ GD 2

150057062000 Großanzeige KPZ GD2-1 6-stellig, 76 mm LED's dot Matrix, mit 5m Anschlußkabel und Interface zum Anschluß an die Anzeige KPZ 52 (E)-*



PC Software K-PZ Smart Scale

Software K-PZ Smart Scale is a modern software specially designed to manage weighing data. A custom function selection is possible depending on different stages of development. Moreover, it is possible to customize software according to customer requirements.

It provides an extremely user-friendly interface and easy of operation.

Software used to manage weighing data, transmitted via the interface of the scale.

It saves time and transmission errors that may occur by manual data input.

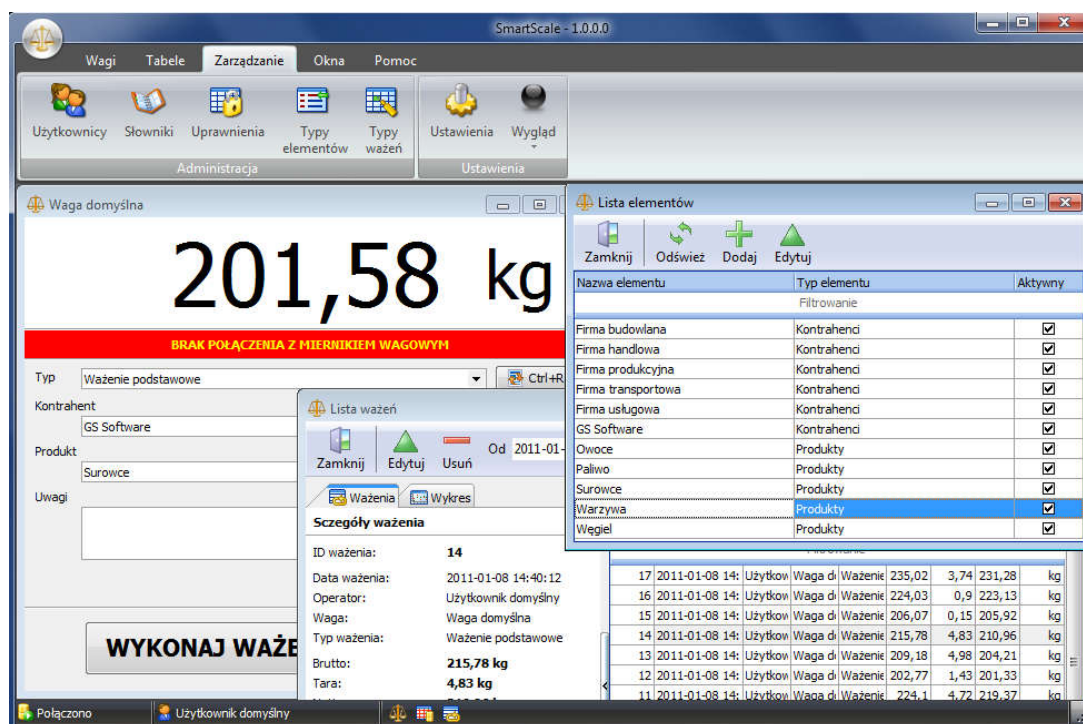

View of the main window

Depending on the configuration following option possible :

- Adjustment of customer-specific data
- Admin data managing
- User managing
- Export to TXT, CSV, RTF, JPG, XLS file
- Print out
- Label printing

Software comes with a USB flash drive activation key.

system Requirements:

Minimum requirements:

- hardware – Processor Intel Pentium 4, 512 MB RAM, 100 MB of the hard drive free;
- software: Windows 2000 (SP4), XP (SP2), Vista, Win7

Depending on version of KPZ Smart Scale , the following functionality is possible:

Function	Programm version		
	Standard	Professional	Premium
Facility to connect only one scale indicator	X		
Facility to connect any number of indicators the same time		X	X
Handling any model of KPZ indicator	X	X	X
Access to weighing list data window	X	X	X
Export weighing list data to the .TXT or .CSV file	X	X	X
Export weighing list data to the .XLS file (installation of MS Excel not necessary)		X	X
Weighing list data overview on the chart	X	X	X
Save the chart (weighing list data) as a picture	X	X	X
Weighing search	X	X	X
Weighing ticket preview	X	X	X
Save weighing ticket as PDF file	X	X	X
Edit data assigned to the weighing	X	X	X
History of weighing changes preview			X
Access to the Report Generator		X	X
Generating report to any data		X	X
Save the report as .PDF file		X	X
Export report data to .RTF, .CSV, .JPEG, XLS file (installation of MS Excel is necessary)		X	X
Export report data to . XLS file (installation of MS Excel not necessary)			X
Using programm as default user (with out Log in-Panel)	X		
Using programm as defined User or Admin		X	X
User Authorization Management			X
Facility to perform weighing without additional data	X	X	X
Facility to perform weighing with additional data: contractor, product, comments,	X	X	X
Facility to perform weighing with additional data: contractor, product, comments, + 2 additional dictionaries, + 2 additional text fields		X	X
Facility to perform weighting with any data type. Possibility to build any data structure.			X
Access to the window allowing to create dictionaries in a database			X
Network version		X	X
Print out as graphic or text mode	X	X	X
Facility to print out the logo on the ticket weighting (graphic mode)	X	X	X
Facility to create license data (one set only)	X		
Facility to create any number of license data set		X	X
Virtual Scales mechanism (planned)		X	X
Label ticket operation (planned)		X	X
Multi-language	X	X	X

Printers for KPZ scales

More printers and options on request!

Thermal printer Favorit 24	
Dimensions	85 x 85,5 mm (B x H)
Own weight	150 g
Power supply	Scale's battery
Interface	serial RS232
Version	Thermo-Direkt-Drucker, 203 dpi,
Paper	Paper width: 57 mm



Ticket printer DR 2	
Dimensions	93x173x190 mm (B x H x T)
Own weight	1,2 kg
Power supply	230 VAC / 20 V DC 2,5 A
Interface	serial RS232, Parallel
Version	Thermo-Direkt-Drucker, 203 dpi,
Paper	Etiquette width : max 61mm



Ticket printer DR 6	
Dimensions	ca. 109 x 171 x 209 mm (B x H x T)
Own weight	ca. 1,2 kg
Power supply	100-240 VAC / 24 VDC 2,1 A
Interface	seriell RS232, Parallel
Version	Thermo-Direkt-Drucker, 203 dpi,
Paper	Etiquette width: 15-60mm



Thermal printer Favorit	
Dimensions	85 x 85,5 mm (B x H)
Own weight	150 g
Power supply	Scale's battery
Interface	serial RS232
Version	Thermo-Direkt-Drucker, 203 dpi,
Paper	Paper width: 57 mm



Rollerprinter DR 7	NEW
Dimensions	110 x 125 x 70 mm (B x H x T)
Own weight	600 g
Power supply	230 VAC / 9 V DC 3,2 A
Interface	RS232, USB
Version	Thermo-Direkt
Paper	Papierbreite: 58mm, 20m, Ø40mm



Rollerprinter DR 7	
Dimensions	160 x 139 x 248 mm (B x H x T)
Own weight	2,3 kg
Power supply	230 VAC / 20 V DC 2,5 A
Interface	serial RS232, Parallel
Version	9- Needle printer, alphanumerischer Ausdruck
Paper	Paper width: 76 , 69,5 or 57,5 mm max. 40 digits on column



K-PZ Waagen
 Kanalsteck 9
 21129 Hamburg
 Tel. 040 / 742174-0
 Fax 040 / 742174-99
 TICKET NO. 1
 Art.-Nr.: 123456
 PCS 40
 APW 100 g
 G 5.001 kg
 T 1.000 kg
 N 4.001 kg



KPZ 719SJDR
Exemplary formats
Indikátor KPZ 52 19



TICKET NO.0001
GS 124.5 kg
TR 20.0 kg
NT 104.5 kg

TICKET NO.0002
GS 124.0 kg
TR 20.0 kg
NT 104.0 kg

TOTAL NUMBER
OF TICKETS 0002
TOTAL WEIGHT
248.5 kg

Indicator KPZ 5218



23/08/2016, 16:42:45

TICKET NO. 0001
G 2.0kg
T 0.0kg
N 2.0kg

23/08/2016, 16:43:01

TICKET NO. 0002
G 5.6kg
T 0.0kg
N 5.6kg

23/08/2016, 16:43:13

TOTAL NUMBER
OF TICKETS 0002
TOTAL
NET 7.6kg

KPZ printers

Exemplary formats / Indicator KPZ 52(E) – 7 / Indicator KPZ 52(E) - 8

Examples are standard formats to printers KPZ. Possibility computer formats. Possibility of formats on customer request!

Exemplary print out Simple format 3	
S/N	WT/kg
0001	100,0
0002	200,0
0003	300,0
0003	600,0

Exemplary print out Complete format 4	
TICKET NO.0001	
G	100,0g
T	0,0g
N	100,0g
TICKET NO.0002	
G	200,0g
T	0,0g
N	200,0g
TICKET NO.0003	
G	300,0g
T	0,0g
N	300,0g
TOTAL NUMBER OF TICKETS 0003	
TOTAL	
NET	600,0g

G = Gross
T = Tare
N = Netto

Exemplary print out Stable format 5	
S/N	WT/kg
0001	100,0
0002	200,0
0003	300,0
0003	600,0

KPZ printers

Exemplary formats / Indicator KPZ 56-3/ KPZ 56-4 / KPZ 2-04-7 scale

Examples are the standard formats. Other formats are possible on request.

Example - format 1:

20.000	kg
7.975	kg
12.125	kg
13.380	kg

Example - format 2:

Ticket NO.	1	
Q'TY	40	PCS
APW	100	g
G/B	5.000	kg
T	1.000	kg
N	4.000	kg

Ticket NO.	2	
Q'TY	290	PCS
APW	100	g
G/B	30.000	kg
T	1.000	kg
N	29.000	kg

TOTAL TICKETS:	2
TOTAL Q'TY:	330 PCS

Example - format 3:

Date:	03-03-00	
Time:	09:04:43	
ID#:	123456789012345	
Part#:	543210987654321	
Ticket NO.	1	
Q'TY	40	PCS
APW	100	g
G/B	5.000	kg
T	1.000	kg
N	4.000	kg

Date:	03-03-00	
Time:	09:04:43	
ID#:	123456789012345	
Part#:	543210987654321	
Ticket NO.	2	
Q'TY	290	PCS
APW	100	g
G/B	30.000	kg
T	1.000	kg
N	29.000	kg

TOTAL TICKETS:	2
TOTAL Q'TY:	330 PCS

Example - format 4:

S/N	WT/kg	PCS
1.	20.000	3333
2.	20.000	3333
3.	8.000	1333
3/	TOTAL	Q'TY:
	7999	PCS

Example - format 5:

Date:	03-03-00	
Time:	09:04:43	
ID#:	123456789012345	
Part#:	543210987654321	
S/N	WT/kg	PCS
1.	20.000	3333
2.	20.000	3333
3.	8.000	1333
3/	TOTAL	Q'TY:
	7999	PCS

Printing formats

Indicator KPZ 56E-3 / KPZ 56E-4

Scale KPZ 2-04E-7

inkl. PT and Addition

standard format

NO.	1
G	276.7 kg
T	104.5 kg
PT	22.2 kg
N	150.0 kg
U/W	12 kg
PCS	13 pcs

NO.	2
G	176.7 kg
T	104.5 kg
PT	22.2 kg
N	50.0 kg
U/W	12 kg
PCS	4 pcs

=====	
T/N	2
T/W	200.0 kg
T/A	17 pcs

PT = Pretare

U/W = Unit Weight

PCS = Quantity

T/N = Total weighings

T/W= Total Netto weight

T/A= Total quantity

Indicator KPZ 51E-9-2

Example - format 1:

DATE:	03/03/2000
TIME:	09:04:43
TICKET NO.	01
NET:	+ 4.500 kg
GROSS:	+ 6.000 kg
TARE:	+ 1.000 kg
PRETARE:	+ 0.500 kg

DATE:	03/03/2000
TIME:	09:04:55
TICKET NO.	02
NET:	+ 5.500 kg
GROSS:	+ 6.000 kg
TARE:	+ 0.000 kg
PRETARE:	+ 0.500 kg

DATE:	03/03/2000
TIME:	09:05:35
TOTAL NO.	02
TOTAL NET:	+ 5.500 kg



KPZ 2-11-3 **M**



KPZ 2-06A **M**

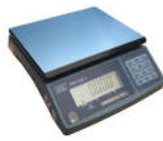

KPZ 2-02-4 **M**



KPZ 2-04-7 **M**
 Counting scales



KPZ 2-04 **M** IP67



KPZ 2E-06S **M** **Ex**



KPZ 2082 weighing system



Klasse III
 KPZ 1 **M** **Ex**



KPZ 1 B **M** KPZ 2 B **M**



Klasse III
 KPZ 2S(E) **M** **Ex**

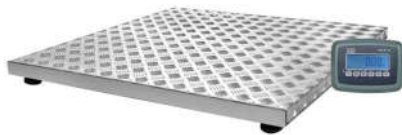

KPZ 2ECO , 0-300kg **M**



Go through scales **M**



KPZ 2D **M** **Ex**



KPZ 71-* **M** **Ex**



KPZ 72 **M** **Ex**



KPZ 73B



KPZ 73SDJ



KPZ 73 **M**



KPZ 74 **M**



KPZ 76 **M**
 Weighing forks



KPZ 39
 Hydraulic
 weighing system



Crane scales **M**



Scale for
 Coils



Scales for animals
M



KPZ PC Software

German design and own EU production guarantees high quality.

Special models are our speciality!

Mobile KPZ scales



KPZ 71-7 **M**  
Many Option possible



Option KPZ 71-7



KPZ 71-8 **M**
2.200kg / 200g



KPZ 71-9
2.200kg / 500g

KPZ 72 **M**



KPZ 72, 2400mm, 3200kg



KPZ 73 **M**



KPZ 73 SDJ **M**



KPZ 73 B **M**



KPZ 74 **M**



Weighing forks Forklift truck scale



KPZ 39
Electronic – Hydraulic version



Touch sreen Indicator 7-Zoll



Scale for Coil's



German design and own EU production guarantees high quality.

Stainless steel Material : DIN 1.4301 / 1.4541 / 1.4404

KPZ-Waagen, Stainless steel scale and Indicator, IP 67/68/69K



Platform Scale KPZ 2N, Stainless steel, IP 67/68/69 K

Stainless steel Material : DIN 1.4301 / 1.4541 / 1.4404

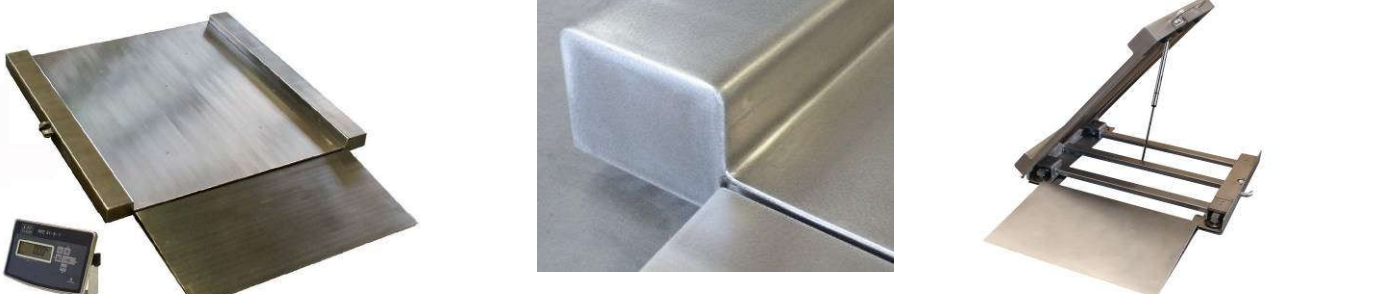

Low construction scale KPZ 2DN

Plain, top plate of platform made of one piece. IP 67/68/69K

Stainless steel Material : DIN 1.4301 / 1.4541 / 1.4404



**Pallet weigher Type: KPZ 71-7N
 stainless steel DIN 1.430, IP 67/68/69K**

**Pallet scale KPZ 1N, IP 67/68/69K
 Stainless steel - Material 1.4301**



**Bench Scale KPZ 2E-06, stainless steel DIN 1.430, IP 67/68, IP 69K
 German design and own EU production guarantees high quality.**

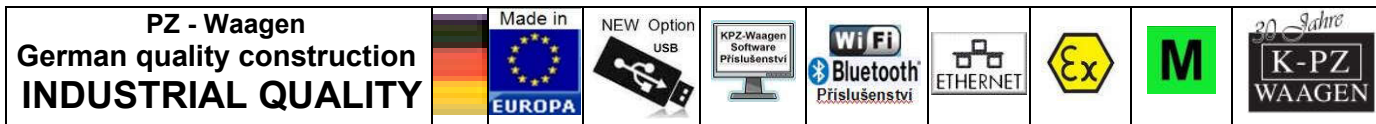

200305 00 N UK €



KPZ - Váhy, s. r. o.

Libošovice 76,
CZ 507 44 Libošovice

Tel.:

+420 736 622 710

+48 661 033 820

+420 493 571 111

email: / zander@kpzwaagen.de / kpz@kpz-vahy.cz

www.kpzwaagen.com