

KPZ 2-04-8 / Highly accurate counting scale
Robust highly accurate counting scales up to 30 kg for industrial use
 Indicator division: 1/60.000 with internal division up to 1/600.000



Counting scale KPZ 2-04-8 platform dimensions are 230 x 300 mm.

This high quality, highly accurate counting scale can be used anywhere in industry . On the basis of high resolution and precision of internal resolution can be easily calculated a large number of small parts . Furthermore, it follows from this great stability and repeatability.

Indicator with 3 LCD-display allows the operator to capture all the important data at a glance. This extremely durable construction, an additional protection against moisture resistant battery built and optimized using waterproof membrane keypad makes this counting scale indispensable daily helper cell. The scale can be powered by battery or mains. The platform is made of stainless steel and is removable for cleaning

Standart options:

- Indicator division: 1/60.000 with internal division up to 1/600.000
- Programmed auto calibration
- Automatic zero setting
- Counting (smallest weight 1/5 division of Indicator). Scale counts small pieces.
- Tare value can be weight or put manually.
- Scale has over **100** (freely programmable) memory for the number of goods and description of goods.
- Place the loaded amount of memory in addition to counting parts in the overall piece, and its total weight
- Weight and quantity (calculated results) can be added in memory .
- Quantity and weight control , weighing in tolerance section (Checkweighing)
(Signal tone when crossing weight value).

Functions : 3 LCD's, 6-digit, 20 mm high, $\pm 100\%$ -tare weight input by weighing-in or manual input, negative value indication, automatic calibration, manual and automatic addition function, check function for piece quantity, check function for weight, automatic piece weight new calculation. Self-test function, automatic zero setting, NET weight display, scale 1 or 2-function indication, Memory accumulation M+, operating temperature : from 0°C up to +40°C.

Typ	Capacity	Div.	Approval possibility	Dim. mm.	Art.nr..
2-04-8/3000	3.000g	0,05g	No	230x300mm	204803000000
2-04-8/6	6.000g	0,1g	No	230x300mm	204806000000
2-04-8/15	15.000g	0,2g	No	230x300mm	204801500000
2-04-8/30	30.000g	0,5g	No	230x300mm	204803000000

Options / accessorie / extra charge		
Serial interface RS 232		123070000000
Roller printer FAVORIT 24 Plus		120024000000

Typ	capacity	Packing dimension
KPZ 2-04-8	all	45 x 38 x 21 - 5kg

**24 months
warranty**

KPZ Bench / Table and Counting Scale



KPZ 2-02-4(E) M
Universal Precision scale
Inexpensive version



KPZ 2-04(E)-7 M
High resolution and counting
Precision scale
Inexpensive version



KPZ 2-04-8
High accuracy counting scale

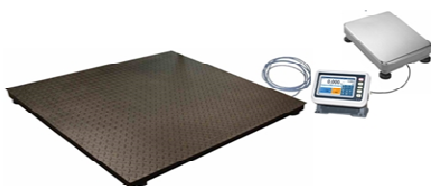

KPZ 2-08-2 M
Dual Digital counting scale system



KPZ 2-03-10(E) M
Digital Multi-Purpose Scale
IP 65



KPZ 2(E)-06A M / Bench scale
Inexpensive version



KPZ 2(E)-06S M Bench scale
Capacity up to 900kg
Weighing + Counting



KPZ 2E06N M Bench Scale
Stainless steel, DIN 1.4301 /
IP67/68 and IP 69K



KPZ 2113
Postal Scale
Capacity : up to 60 kg
Inexpensive version



KPZ 2114
Digital VET Platform scale
Capacity : up to 150/300kg



KPZ 2E-07-2N M
Wall folding scale
Stainless steel, DIN 1.4301 / IP67/68
and IP 69K

Special models are our speciality!

24 months
warranty

KPZ 2-02-4(E) / Universal Precision scale **M**

Robust Universal scales for industrial weighing

Capacity : up to 30 kg / Resolution up to 1/ 30.000 division

High resolution
Reference Counting
Hand tare
Add function
inexpensive
230 V mains
Option : Battery



Inexpensive version

Properties:





12 large function keys for easy operation
Basic Functions: Zero, Tare:
Weigh or keyboard input
Reference piece counting 10, 20, 50, 100 pieces,
Setpoint examination - Lo / Ok / Hi Function
Robust ABS housing
Stainless steel platform 285 x 215mm
High resolution up to 30.000d

Power supply: 230VAC power cord

Option : battery, indication of charging status

Technical data

Large LCD display, backlit (6 digits, 25mm high)
Temperature range: -10 ° to 40 ° C
Dim. WxDxH ca. 292x340x106mm
Approvals: OIML class III **M**, CE conform
Power Supply : 230 V mains, Power cord
Option:Battery

Typ	Capacity	Div.	Dim. mm.	Approval possibility	Art.-No
KPZ 2-02-4	3 kg	0,1 g	220 x 315 mm	No	202400300000
KPZ 2-02-4	6 kg	0,2 g	220 x 315 mm	No	202400600000
KPZ 2-02-4	15 kg	0,5 g	220 x 315 mm	No	202401500000
KPZ 2-02-4	30 kg	1,0 g	220 x 315 mm	No	202403000000
KPZ 2-02(E)-4	3 kg	1,0 g	220 x 315 mm	YES 	2024E0030000
KPZ 2-02(E)-4	6 kg	2,0 g	220 x 315 mm	YES 	2024E0060000
KPZ 2-02(E)-4	15 kg	5,0 g	220 x 315 mm	YES 	2024E0150000
KPZ 2-02(E)-4	30 kg	10 g	220 x 315 mm	YES 	2024E0300000

Options / accessorie / extra charge		
Serial interface RS 232		123070000000
Roller printer FAVORIT 24 Plus		120024000000

Factoryfirst certification (extra charge)		Artikel-Nr.
For Capacity from 0 kg bis 21 kg		300PL0000020
For Capacity from 21 kg bis 200 kg		300PL0000200

Packing Dimension				
KPZ 2-04(E)-7	42 x 39 x 20 cm		7 kg	

24 months warranty

KPZ 2-03-10(E) / Digital Multi-Purpose Scale

Robust digital Multi-purpose scale, IP 65

Capacity : up to 30 kg / Division up to **30.000**

KPZ 2-03-10 high accuracy, waterproof, sturdy, reliable digital scale can be used for all industrial weighing applications.

With its user friendly operation, this fully portable AC & Accu operated unit,, incorporates simple operating keys with a clear 6 digit, 25 mm high LCD – Display, making this scale an inexpensive daily assistant within the office & industrial workplace.

Basic Features include:



- Waterproof IP 65
- Mains & battery powered
- LO BAT indication
- Mains adaptor (inc. in price)
- Automatic ZERO trekking
- Manual ZERO setting
- 100 % tare
- 6-digit, 25 mm high, LCD-Display
- Display backlight
- Automatic calibration
- Gross / Net display
- Simple component counting



This high accuracy, waterproof, sturdy, reliable digital scale can be used for all industrial weighing applications.

With its user friendly operation, this fully portable AC & Accu operated unit,, incorporates simple operating keys with a clear 6 digit, 25 mm high LCD – Display, making this scale an inexpensive daily assistant within the office & industrial workplace. **Approvals:** OIML class III  , CE conform, **Power Supply** : 230 V mains, Power cord

Operating condition : 0°C to 40°C

Typ	Capacity	Div.	Dim. mm.	Approval possibility	Art.-No
KPZ 2-03-10	6.000g	1,0g	192 x 225 mm	No	203100600000
KPZ 2-03-10	30.000g	5,0g	192 x 225 mm	No	203103000000
KPZ 2-03-10	6.000g	0,5g	192 x 225 mm	No	20310H600000
KPZ 2-03-10	15.000g	1,0g	192 x 225 mm	No	20310H150000
KPZ 2-03-10	30.000g	1,0g	192 x 225 mm	No	20310H300000
KPZ 2-03E-10	6.000g	1,0g	192 x 225 mm	YES 	203E10060000
KPZ 2-03E-10	15.000g	5,0g	192 x 225 mm	YES 	203E10150000
KPZ 2-03E-10	30.000g	10,0g	192 x 225 mm	YES 	203E10300000

Options (extra charge)	Article-Nr
Capacities, certification and division:	
Schale, rostfrei Stahl, 246 x 222 x 42 mm	204300080000
Serial interface RS 232	203100070000
Printer DR 7	120039000000
Printer DR 7 with date & time	120039100000
Printer Info and Printout Example Starts from Page 14	

Factoryfirst certification (extra charge)	Artikel-Nr.
For Capacity from 0 kg bis 21 kg	300PL0000020
For Capacity from 21 kg bis 200 kg	300PL0000200

Packing :		
KPZ 2-03-3	all	41 x 38 x 20 cm, 7,0 kg

KPZ 2-04(E)-4 / High resolution and Precision counting scale

High resolution for easy and accurate piece counting / For use with or without EU approval /



Characteristics: 20 function keys for easy operation

Basic functions: zeroing, taring, piece counting, adding,
Piece weight memory, setpoint control

The tare value and the piece weight can be weighed or
entered via the keyboard

Piece counting (smallest piece weight 1/5 of the display pitch).

The scale has **50 memory** units for piece weight, tare,
Articles and ID / PLU Codes (Product Identification Numbers)

Weight and amount addition memory

Quantity or weight control (beep and display)



Power supply: · Battery operation, charge level indicator, · 230VAC power cord

Technical specifications: LCD 3 LCD displays for weight, unit weight and Quantity, backlit (17mm high)

Robust ABS housing, 4 heightadjustable feet and level for precise leveling. Stainless steel platform 320x250 mm









Temperature range: -10 ° to 40 ° C. Dim. WxDxH approx. 315x353x135mm.

High resolution version

Ad graduation 1 / 30,000 with an internal division of 1 / 600,000. Smallest part weight 1/5 of the display division.

Advanced features and optional possibilities (extra charge):

Connection: RS232 serial interface for printer or PC.

Typ	Capacity	Div.	Dim. mm.	Approval possibility	Art.-No
KPZ 2-04-4	3 kg	0,1 g	320 x 250	No	2044H0300000
KPZ 2-04-4	6 kg	0,2 g	320 x 250	No	2044H0600000
KPZ 2-04-4	15 kg	0,5 g	320 x 250	No	2044H1500000
KPZ 2-04-4	30 kg	1,0 g	320 x 250	No	2044H3000000
KPZ 2-04-4	15 kg	1,0 g	320 x 250	No	204401500000
KPZ 2-04-4	30 kg	2,0 g	320 x 250	No	204403000000
KPZ 2-04(E)-7	3 kg	1,0 g	320 x 250	YES  	2044E0030000
KPZ 2-04(E)-7	6 kg	2,0 g	320 x 250	YES  	2044E0060000
KPZ 2-04(E)-7	15 kg	5,0 g	320 x 250	YES  	2044E0150000
KPZ 2-04(E)-7	30 kg	10 g	320 x 250	YES  	2044E0300000

Options / accessories / extra charge	Article-Nr
Serial interface RS 232 incl. PT and Addition	204400070002
Serial interface RS 232 incl. RTC, w/out PT, w/out addition	204400070001
Printer DR 7	120039000000
Printer DR 7 with date & time	120039100000
Printer Info and Printout Example Starts from Page 14	

Factoryfirst certification (extra charge)	Artikel-Nr.
For Capacity from 0 kg bis 21 kg	300PL0000020
For Capacity from 21 kg bis 200 kg	300PL0000200

Packing Dimension			
KPZ 2-04(E)-4	42 x 39 x 20 cm		7 kg

**24 months
warranty**

Inexpensive, high resolution precision scale

KPZ 2-04(E)-7 / Counting Precision scale
Robust Counting scales up to 30 kg for industrial use
 For use with or without EU approval /

Very good price performance
 High resolution
 Add function
 Taravoreingabe
Option : Battery

Characteristics:

- 20 function keys for easy operation
- Basic functions: zeroing, taring, Piece counting, adding, piece weight storage, Setpoint control
- The tare value and the piece weight can be weighed or entered via the keyboard become
- The scale has 50 memory for Piece weight, tare, article and (Product identification numbers)
- Weight and amount addition memory
- Quantity or weight control (beep and Display when exceeding)

Power supply: · Battery operation (optional), charge status display · 230VAC power cable



Technical specifications: · 3 LCD displays for weight, unit weight and Quantity, backlit (17mm high). Robust ABS housing, 4 height adjustable feet and level for precise leveling. Stainless steel platform 285x215 mm. · Temperature range: -10 ° to 40 ° C. Dim. WxDxH approx. 292x340x106mm

Typ	Capacity	Div.	Dim. mm.	Approval possibility	Art.-No
KPZ 2-04-7	3 kg	0,1 g	220 x 315 mm	No	204700300000
KPZ 2-04-7	6 kg	0,2 g	220 x 315 mm	No	204700600000
KPZ 2-04-7	15 kg	0,5 g	220 x 315 mm	No	204701500000
KPZ 2-04-7	30 kg	1,0 g	220 x 315 mm	No	204703000000
KPZ 2-04(E)-7	3 kg	1,0 g	220 x 315 mm	YES	2047E0030000
KPZ 2-04(E)-7	6 kg	2,0 g	220 x 315 mm	YES	2047E0060000
KPZ 2-04(E)-7	15 kg	5,0 g	220 x 315 mm	YES	2047E0150000
KPZ 2-04(E)-7	30 kg	10 g	220 x 315 mm	YES	2047E0300000

Options / accessories / extra charge	Article-Nr
Stainless steel platform, 246 x 222 x 42 mm	204300080000
Serial interface RS 232 incl. PT and Addition	204300070002
Serial interface RS 232 incl. RTC, w/out PT, w/out addition	204300070001
Printer DR 7	120039000000
Printer DR 7 with date & time	120039100000
Label printer DR 2 for RS 232, KPZ 2-04-4	204333000000
Print desing for DR 2 on request	204333100000
Printer Info and Printout Example Starts from Page 14	

Factoryfirst certification (extra charge)	Artikel-Nr.
For Capacity from 0 kg bis 21 kg	300PL0000020
For Capacity from 21 kg bis 200 kg	300PL0000200

Packing Dimension	
KPZ 2-04(E)-7	42 x 39 x 20 cm

**24 months
warranty**

Inexpensive, high resolution precision scale

6

KPZ-Váhy s.r.o. • Libošovice 76 • CZ507 44 Libošovice • GSM: 00420736622710 • Email: zander@kpzwaagen.de •
KPZ-Waagen - 30years - AFFORDABLE, ROBUST and GOOD !! www.kpzwaagen.com

We reserve the right to make technical modifications and price changes without prior notification. Warranty: The parts and components are warranted for two years from the date of delivery against defects in materials and workmanship, provided proper and normal use condition, excluding batteries and chargers.

KPZ 2-04-8 / Highly accurate counting scale
Robust highly accurate counting scales up to 30 kg for industrial use
 Indicator division: 1/60.000 with internal division up to 1/600.000



Counting scale KPZ 2-04-8 platform dimensions are 230 x 300 mm.

This high quality, highly accurate counting scale can be used anywhere in industry . On the basis of high resolution and precision of internal resolution can be easily calculated a large number of small parts . Furthermore, it follows from this great stability and repeatability.

Indicator with 3 LCD-display allows the operator to capture all the important data at a glance. This extremely durable construction, an additional protection against moisture resistant battery built and optimized using waterproof membrane keypad makes this counting scale indispensable daily helper cell. The scale can be powered by battery or mains. The platform is made of stainless steel and is removable for cleaning

Standart options:

- Indicator division: 1/60.000 with internal division up to 1/600.000
- Programmed auto calibration
- Automatic zero setting
- Counting (smallest weight 1/5 division of Indicator). Scale counts small pieces.
- Tare value can be weight or put manually.
- Scale has over **100** (freely programmable) memory for the number of goods and description of goods.
- Place the loaded amount of memory in addition to counting parts in the overall piece, and its total weight
- Weight and quantity (calculated results) can be added in memory .
- Quantity and weight control , weighing in tolerance section (Checkweighing)
(Signal tone when crossing weight value).

Functions : 3 LCD's, 6-digit, 20 mm high, $\pm 100\%$ -tare weight input by weighing-in or manual input, negative value indication, automatic calibration, manual and automatic addition function, check function for piece quantity, check function for weight, automatic piece weight new calculation. Self-test function, automatic zero setting, NET weight display, scale 1 or 2-function indication, Memory accumulation M+, operating temperature : from 0°C up to +40°C.

Typ	Capacity	Div.	Approval possibility	Dim. mm.	Art.nr..
2-04-8/3000	3.000g	0,05g	No	230x300mm	204803000000
2-04-8/6	6.000g	0,1g	No	230x300mm	204806000000
2-04-8/15	15.000g	0,2g	No	230x300mm	204801500000
2-04-8/30	30.000g	0,5g	No	230x300mm	204803000000

Options / accessiores / extra charge		
Serial interface RS 232		123070000000
Roller printer FAVORIT 24 Plus		120024000000

Typ	capacity	Packing dimension
KPZ 2-04-8	all	45 x 38 x 21 - 5kg

**24 months
warranty**

2-08-2 / Dual Digital counting scale system

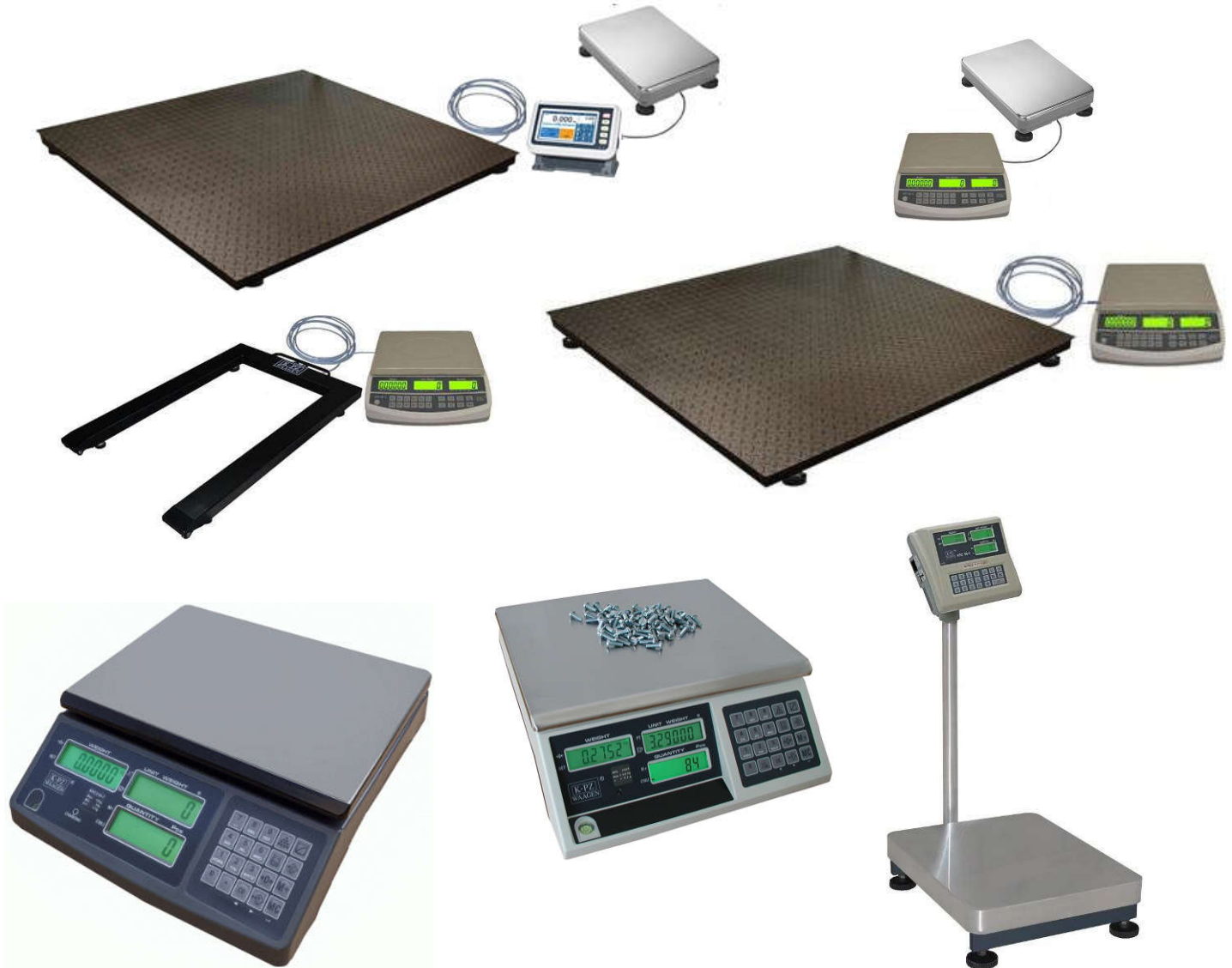

counting problems ?

Special requirements - please contact us for more information!

German design and own EU production guarantees high quality.

Special models are our speciality!

KPZ 2(E)-06A / Bench scale

Robust Universal Bench scale for industrial use

Capacity : up to 75 kg



Construction: Robust, maintenance-free, design for industrial use, Stainless steel weighing platform.

Load cells: Robust, single point load cell, IP68, OIML, with a high overload capacity.

Installation: Adjustable leveling feet, designed for permanent or portable installations, 1,5m cable to connect digital indicator.

Approvals: OIML class III , CE conform

Power Supply: 230 V mains, Power cord

Options: Back holder, Wall mounting for indicator, Indicator stand, Custom sizes and capacities

Standard indicator: KPZ 52-18

For approved applications: KPZ 52E-8

Options for indicators:

Multi range,
RS 232 serial interface,
Various printers connection,
Radio data transfer,
WLAN, etc..
Internal battery

Special requirements for unique loading - please contact us for more information!

Typ	Capacity	Div.	Dim. mm.	Approval possibility	Indicator	Art.-No
KPZ 206A		0,5g	300 x 400 x 120	No	KPZ 52-18	206A00063400
KPZ 2E06A		2g	300 x 400 x 120	yes 	KPZ 52E-8	2E06A0006340
KPZ 206A	7,5 kg	1g	300 x 400 x 120	No	KPZ 52-18	206A00153400
KPZ 206AH	6 kg	0,5g	300 x 400 x 120	No	KPZ 52-18	2H06A0015340
KPZ 2E06A	15 kg	5g	300 x 400 x 120	yes 	KPZ 52E-8	2E06A0015340
KPZ 2E06AM	15/30 kg	5/10g	300 x 400 x 120	yes 	KPZ 52E-8	2E06AM030340
KPZ 206AH	30 kg	1g	300 x 400 x 120	No	KPZ 52-18	2H06A0030340
KPZ 206A	30 kg	2g	300 x 400 x 120	No	KPZ 52-18	206A00303400
KPZ 2E06A	30 kg	10g	300 x 400 x 120	yes 	KPZ 52E-8	2E06A0030340
KPZ 206AH	60 kg	2g	300 x 400 x 120	No	KPZ 52-18	2H06A0060340
KPZ 206A	75 kg	5g	300 x 400 x 120	No	KPZ 52-18	206A00603400
KPZ 2E06A	60 kg	20g	300 x 400 x 120	yes 	KPZ 52E-8	2E06A0060340

KPZ price includes complete scale with indicator.

**24 months
warranty**

Special models are our speciality!

Options / accessories / extra charge	Article-Nr
Indicators: Options (extra cost)	
Delivery without Indicator KPZ 52E-8, REDUCED PRICE	1252E8OHNE00
Delivery without Indicator KPZ 52-18, REDUCED PRICE	125218OHNE00
Indicator KPZ 52E-8 instead of KPZ 52-18	1252E8000000
Indicator KPZ 52E-8/1, with pre tare and easy counting instead of KPZ 52E-8	120030000000
Indicator KPZ 52E-8/1, with pre tare and easy counting instead of KPZ 52-18	12J030000000
Indicator KPZ 56E-3, professional counting, addition, Tare input by hand, instead of KPZ 52E-8	120324000000
Indicator KPZ 56E-3, professional counting, addition, Tare input by hand, instead of KPZ 52-18	120324000000
Indicator KPZ 52E-9-1, Stainless steel housing (IP 67) easy counting instead of KPZ 52E-8	1252E9100000
Indicator KPZ 52E-9-1, Stainless steel housing (IP 67) easy counting instead of KPZ 52-18	1252J9100000
Printers: Options (extra cost) + costs for output RS 232	
Roller printer FAVORIT Plus, for KPZ 51(E)-*,	120024000000
Printer DR 7	120039000000
Printer DR 7 with date & time	120039100000
Label printer and code printer type DR 2 for KPZ 56E-1, KPZ 51E-9-2	120038000000
Print design for DR 2 on request	204333100000
serial interface / Setpoints: Options / extra costs	
Serial interface RS232 C for KPZ 52E-8	1252E8000100
Serial interface RS232 C for KPZ 52-18	511830700000
Serial interface RS232 C for KPZ 52E-9-1	123071000000
Serial interface RS232 C for KPZ 51E-9-2	123072000000
Serial interface RS232 C for KPZ 56E-3 incl. PT and Addition	123080000000
Serial interface RS232 C for KPZ 56E-3 incl. RTC, w/out PT, w/out Addition	204300070000
Setpoints, 3 pcs for KPZ 52(E)-8 (more – OK – less)	120029001000
Setpoints, 3 pcs for KPZ 51E-9-2 (more – OK – less)	120029002000
Software "KPZ Smart Scale" STANDARD (incl. RS232 serial interface)	5S0001000000
Software "KPZ Smart Scale" PROFESSIONAL (incl. RS232 serial interface)	5S0005000000
Software "KPZ Smart Scale" PREMIUM (incl. RS232 serial interface)	5S0010000000
Wi-Fi Datatransfer	120005000000
Rechargeable battery version KPZ 51(E)-8, 56E-1, 51E-9-1, 51E-9-2	120040000000
construction accessories (extra charge)	
Indicator stand for KPZ 52(E)-8, KPZ 56E-3	1S0200000000
Indicator stand for KPZ 52-18,	1S0220000000
Indicator stand for KPZ 52(E)-9-1, KPZ 51E-9-2 Powder painted	1S0210000000
Wall mounting indicator KPZ 52(E)-8, KPZ 56E-3	1S0020000000
Wall mounting indicator KPZ 52-18	1S0022000000
Cable Protection against mouse bite	
longer cables	
Fixing plates for the load cell feet (Set of 4 pcs.)	
Special overload protection at high load	
Weighing plate to open	
Factoryfirst certification (extra charge)	
For Capacity from 21 kg bis 200 kg	300PL0000200
For Capacity from 201 kg bis 500 kg	300PL0000500
For Capacity from 501 kg bis 3.000 kg	300PL0003000
For Capacity from 3.000 kg bis 10.000 kg	300PL0010000
For Capacity from 21 kg bis 200 kg Double range	300PLM000200
For Capacity from 201 kg bis 500 kg Double range	300PLM000500
For Capacity from 501 kg bis 3.000 kg Double range	300PLM003000
For Capacity from 3.000 kg bis 10.000 kg Double range	300PLM010000

... please contact us for special requests!

KPZ price includes complete scale with indicator.

German design and own EU production guarantees high quality.

Special models are our speciality!



KPZ 2(E)-06S / Bench scale

Robust Universal Bench scale for industrial use
Capacity : up to 800 kg



Standard

spirit-level for adjusting
the scale

Adjustable indicator

Solid and stable Bench scales series KPZ 2E06. **German design and own EU production guarantees high quality.** Designed as Bench scales, industrial weighing. High accuracy. Maintenance-free durable construction. Stainless steel Platform.

Construction: Robust, maintenance-free, design for industrial use, Stainless steel weighing platform. **Load cells:** Robust, single point load cell, IP68, OIML, with a high overload capacity. **Installation:** Adjustable leveling feet, designed for permanent or portable installations, 1,5m cable to connect digital indicator.

Approvals: OIML class III , CE conform. **Power Supply:** 230 V mains, Power cord.

Standard indicator: KPZ 52-18, **For approved applications:** KPZ 52E-8, **Options for indicators:** Multi range, RS 232 serial interface, Various printers connection, Radio data transfer, WLAN, etc.. Internal battery

... please contact us for special requests!















Stainless steel DIN 1.4301 / 1.4541 / 1.4404 and IP 67/68 + IP 69K version possible

German design and own EU production guarantees high quality.

Robust Bench scale for trade and industry!

Special models are our speciality!



Typ	Capacity	Division	Dim. mm	Approval possible	Indicator	Art.-Nr
KPZ 206S	30 kg	2g	420 x 520 x 120	No	KPZ 52-18	206S00304500
KPZ 206SH	30 kg	1g	420 x 520 x 120	No	KPZ 52-18	2H06S0030450
KPZ 2E06S	30 kg	10g	420 x 520 x 120	Yes 	KPZ 52E-8	2E06S0030450
KPZ 2E06SM	30/60 kg	10/20g	420 x 520 x 120	Yes 	KPZ 52E-8	2E06SM060450
KPZ 206S	75kg	5g	420 x 520 x 120	No	KPZ 52-18	206S00604500
KPZ 206SH	60kg	2g	420 x 520 x 120	No	KPZ 52-18	2H06S0060450
KPZ 2E06S	60kg	20g	420 x 520 x 120	Yes 	KPZ 52E-8	2E06S0060450
KPZ 2E06SM	60/120 kg	20/50g	420 x 520 x 120	Yes 	KPZ 52E-8	2E06SM120450
KPZ 206S	150 kg	10g	420 x 520 x 120	No	KPZ 51-18	206S01504500
KPZ 2E06S	150 kg	50g	420 x 520 x 120	Yes 	KPZ 52E-8	2E06S0150450
KPZ 206S	75kg	5g	460 x 600 x 130	No	KPZ 52-18	206S00604600
KPZ 2E06S	60kg	20g	460 x 600 x 130	Yes 	KPZ 52E-8	2E06S0060460
KPZ 2E06S	150 kg	10g	460 x 600 x 130	No	KPZ 52-18	206S01504600
KPZ 2E06S	150 kg	50g	460 x 600 x 130	Yes 	KPZ 52E-8	2E06S0150460
KPZ 2E06SM	150/300 kg	50/100g	460 x 600 x 130	Yes 	KPZ 52E-8	2E06SM300460
KPZ 206S	300 kg	20g	460 x 600 x 130	No	KPZ 52-18	206S03004600
KPZ 2E06S	300 kg	100g	460 x 600 x 130	Yes 	KPZ 52E-8	2E06S0300460
KPZ 206S	75 kg	5g	600 x 600 x 150	No	KPZ 52-18	206S00606600
KPZ 2E06S	60 kg	20g	600 x 600 x 150	Yes 	KPZ 52E-8	2E06S0060660
KPZ 206S	150 kg	10g	600 x 600 x 150	No	KPZ 52-18	206S01506600
KPZ 2E06S	150 kg	50g	600 x 600 x 150	Yes 	KPZ 52E-8	2E06S0150660
KPZ 206S	300 kg	20g	600 x 600 x 150	No	KPZ 52-18	206S03006600
KPZ 2E06S	300 kg	100g	600 x 600 x 150	Yes 	KPZ 52E-8	2E06S0300660
KPZ 206S	75 kg	5g	600 x 800 x 150	No	KPZ 52-18	206S00606800
KPZ 2E06S	60 kg	20g	600 x 800 x 150	Yes 	KPZ 52E-8	2E06S0060680
KPZ 206S	150 kg	10g	600 x 800 x 150	No	KPZ 52-18	206S01506800
KPZ 2E06S	150 kg	50g	600 x 800 x 150	Yes 	KPZ 52E-8	2E06S0150680
KPZ 206S	300 kg	20g	600 x 800 x 150	No	KPZ 52-18	206S03006800
KPZ 2E06S	300 kg	100g	600 x 800 x 150	No	KPZ 52E-8	2E06S0300680
KPZ 206S	500 kg	50g	600 x 800 x 150	Nein	KPZ 52-18	206S05006800
KPZ 206S	75 kg	5g	800 x 800 x 150	No	KPZ 52-18	206S00608800
KPZ 206S	150 kg	10g	800 x 800 x 150	No	KPZ 52-18	206S01508800
KPZ 206S	150 kg	50g	800 x 800 x 150	No	KPZ 52-18	206S01508800
KPZ 206S	300 kg	20g	800 x 800 x 150	No	KPZ 52-18	206S03008800
KPZ 206S	300 kg	100g	800 x 800 x 150	No	KPZ 52-18	206S03008800
KPZ 206S	500 kg	50g	800 x 800 x 150	No	KPZ 52-18	206S05008800

KPZ price includes complete scale with indicator.

Type	Platform	Packing dimension
KPZ 2-06-S	300 x 400 x 120 mm	890 x 390 x 250 mm, 11 kg
KPZ 2-06-S	420 x 520 x 120 mm	830 x 450 x 290 mm, 20 kg
KPZ 2-06-S	460 x 600 x 150 mm	1200 x 800 x 400 mm, 36 kg
KPZ 2-06-S	600 x 600 x 150 mm	1200 x 800 x 400 mm, 47 kg
KPZ 2-06-S	600 x 800 x 150 mm	1200 x 800 x 400 mm, 51 kg
KPZ 2-06-S	800 x 800 x 150 mm	1200 x 800 x 400 mm, 59 kg



Special models are our speciality!

Počítací váha typu KPZ 2E-06S / 56

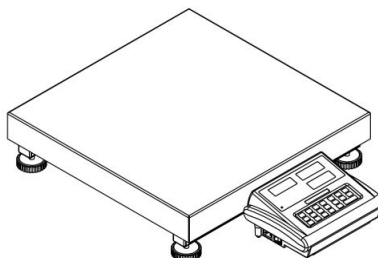

KPZ 56E4

Typ	Váživost	Dělení	Indikátor	Možnost úř. ověření	Rozměry v mm	Obj. č.
KPZ 206S / 56-4	30 kg	2g	KPZ 56E4	Ne	420 x 520 x 120	206560304500
KPZ 206S / 56-4	75kg	5g	KPZ 56E4	Ne	420 x 520 x 120	206560604500
KPZ 206S / 56-4	150 kg	10g	KPZ 56E4	Ne	420 x 520 x 120	206561504500
KPZ 206S / 56-4	30 kg	2g	KPZ 56E4	Ne	460 x 600 x 130	206560304600
KPZ 206S / 56-4	75kg	5g	KPZ 56E4	Ne	460 x 600 x 130	206560604600
KPZ 206S / 56-4	150 kg	10g	KPZ 56E4	Ne	460 x 600 x 130	206561504600
KPZ 206S / 56-4	75kg	5g	KPZ 56E4	Ne	600 x 600 x 150	206560604600
KPZ 206S / 56-4	150 kg	10g	KPZ 56E4	Ne	600 x 600 x 150	206561504600
KPZ 206S / 56-4	300 kg	20g	KPZ 56E4	Ne	600 x 600 x 150	206563004600

Počítací váha typu KPZ 2E-06 / 56 EU ověřitelná třída :Můstková váha typ KPZ 2E-06 / 56. pro cejchuschopné a necejchuschopné nasazení. **Konstrukce:** robustní a kvalitní vysoce hodnotná můstková váha, vyrobená z robustních průmyslově svařované pravoúhlé trubkové oceli, práškově lakované, s nerezovou pokrývací plošinou) univerzální jako Stativ- nebo k nasazení jako stolní verze. **Vážicí systém:** Vybaven hliníkovým DMS-snímačem typu KPZ 504E 2, IP 67, **Schválení** : EU ověřitelná třída přesnosti III, CE Konformní, **Napájení:** 230 Volt síťové napájení. **Provedení:** KPZ 2-06/56 Externí 15.000 dělení, KPZ 2E-06/56 cejchuschopný Standardní 3.000 externích děleních, umožní aby se po dobu 5 sekund vážící hodnota přepnula na rozlišení 15000d. **Indikátor KPZ 56** : Tento kvalitní vysoce hodnotný vysocerozlišitelný počítací indikátor může být použit v cejchuschopném a necejchuschopném nasazení. Na základě vysokého externího rozlišení a 20 krát vyššího vnitřního rozlišení může být bez problémů napočítáno větší množství menších dílů. Mimo jiné se díky tomu dostane vysoká stabilita a opakovaná přesnost. Indikátor na 3 LCD-displejích umožňuje obsluhovateli podchytit všechny důležitá data na jeden pohled. Přepínání není nutné. Tato nadměrně odolná konstrukce, k tomu o chrana proti vlhkosti, zabudovaná znovu nabíjecí baterie a optimální obluha vodotěsné fóliové klávesnice dělají z této váhy nepostradatelného denního pomocníka.

Popis klávesnice

0 bis 9 a .	Klávesou se zadává hmotnost kusu, počet, hodnotová hranice nebo tára -hmotnost
CE:	Klávesou lze vymazat veškeré zadané hodnoty
→0←	1) Touto klávesou se nastaví nula. 2) Dvojitým stiskem klávesy lze zadat úroveň podsvícení displeje.
↔→↑	Touto klávesou se táruje položená hmotnost na váze.
•••••	Klávesa slouží k potvrzení zadaného množství.
□	Klávesou bude potvrzena zadaná hodnota jako hmotnost kusu.
□	Klávesou bude potvrzena zadaná hodnota jako maximální hodnota, počet kusu nebo hmotnost. Pokud by měla být hodnota příliš vysoká, objeví se, vydá se varovný signál.
→B	Klávesou budou vyvolané uložené hmotnosti kusu.
M+	Klávesa přičítání nebo odčítání hodnot do paměti.
MC	Stisknutím této klávesy se nejprve zobrazí a poté smažou nasčítané hodnoty v paměti.
HR/.	Při cejchuschopném provedení : klávesnice vysokého rozlišení/desetinná tečka Aktivace vysokorozlišitelného indikátoru u 3000 d vah. Stiskněte tuto klávesnici po dobu 3 sekund a vážící hodnota se přepne na 5 sekund na rozlišení 15000d.

... oslovte nás, rádi Vám poradíme i při speciálním požadavku !

24 měsíců záruka

KPZ 2113 / Postal Scale

Capacity : up to 60 kg



Standard indicator KPZ 51-16:

The indicator is installed in a robust low profile case with a water and dust-proof keypad. The 25 mm high 6-digit 26 mm high backlite LCD display with status symbols LCD display, a clear indication which is highly visible. For floor & table mounting the indicator has rubber base feet and for wall mounting fixing hole is supplied as standard.



KPZ 51-16-1

Construction: Robust, maintenance-free, Alumin construction, heavy duty design for industrial use, laquert weighing platform.
Load cells: Robust, singl point load cell, IP68, OIML, with a high overload capacity.
Installation: Adjustable leveling feet, designed for permanent or portable installations, 1,5m cable to connect digital indicator.
Power supply: 230VAC mains/charger
 Approvals: CE conform
 Options: Back holder, Wall mounting for indicator, Indicator stand, Custom sizes and capacities

Standard indicator: KPZ 51-16
Weighing Indicator : Indicator KPZ 51-16, inside a robust ABS case, 6-digit 26 mm high backlite LCD display with status symbols.
Basic function: Zero, Tare, gross-/net switching, pieces counting funktion, negative weight indicator, indicator for table and wall mounting.
Energy: Power cord 230V.
 Certification : CE - conform., non approved version
Warranty: The parts and components are warranted for **two years** from the date of delivery against defects in materials and workmanship.

Typ	Capacity	Div.	Dim. mm.	Approval possibility	Indicator	Art-No
2-11-3/36	36kg	5g	360 x 310 mm	No	KPZ 51-16	211300360500
2-11-3/40	40kg	10g	360 x 310 mm	No	KPZ 51-16	211300401000
2-11-3/60	60kg	10g	360 x 310 mm	No	KPZ 51-16-1	211300601000
2-11-3/60	60kg	20g	360 x 310 mm	No	KPZ 51-16	211300600000
2-11-3/75	75kg	20g	360 x 310 mm	No	KPZ 51-16	211300750000
2-11-3/60	60kg	50g	550 x 550 mm	No	KPZ 51-16	211300605000
2-11-3H	15kg	0,5g	360 x 310 mm	No	KPZ 52 18	2113H001500
2-11-3H	30kg	1,0g	360 x 310 mm	No	KPZ 52 18	2113H003000
2-11-3H	60kg	2,0g	360 x 310 mm	No	KPZ 52 18	2113H006000

KPZ price includes complete scale with indicator.

Options / accessories / extra charge	Article-No.
Accu version KPZ 2-11-3	211300600100
Stainless steel platform, 360 x 310mm	211300090000
Mignon batteries 1 Pack = 4 pieces	211300010000
Wall mounting for KPZ 2-11-3	211300600400

Type Packing dimension	Platform	Packing dimension
KPZ 2-11-3	360x310 cm	57 x 37 x 12 cm, 7,0 kg
KPZ 2-11-3	550x550 cm	58 x 58 x 12 cm 8,5 kg

24 months warranty

KPZ 2114 / Digital VET Platform scale

Capacity : up to 150/300kg



KPZ 2-11-4 platform scale, capacity 300 kg, 150/300kg, 50/100g, Multirange, large stainless steel platform: dimension 905 x 505 mm, indicator in robust ABS housing, incl handle, 6 digits 22mm high LCD display with Status symbol, 6 keys, Spiral cable 0,5-1,0m, handle for stand. Basic function: zero setting, tare, Gross-/Net switch, Reference piece counting, Addition
 Properties: Animal weighing function, defines the weight of the moving load, HOLD function, automatic power OFF, Lo/Ok/Hi setting.
 Power supply: internal battery, 230VAC mains/charger
 Certification: CE Konform, non approved version only.

Construction: Robust, maintenance-free, Alumin construction, heavy duty design for industrial use, **laquert weighing platform.**

Load cells: Robust, singl point load cell, IP68, OIML, with a high overload capacity.

Installation: Adjustable leveling feet, designed for permanent or portable installations, 1,5m cable to connect digital indicator.

Power supply: internal battery, 230VAC mains/charger

Approvals: CE conform

Options: Back holder, Wall mounting for indicator, Indicator stand, Custom sizes and capacities

Standard indicator: KPZ 51-16-1

Weighing Indicator : Indicator KPZ 51-16, inside a robust ABS case, 6-digit 26 mm high backlite LCD display with status symbols.

Basic function: Zero, Tare, gross-/net switching, pieces counting funktion, negative weight indicator, indicator for table and wall mounting.

Energy: Power cord 230V.

Certification : CE - conform., non approved version

Warranty: The parts and components are warranted for **two years** from the date of delivery against defects in materials and workmanship.

Special requirements for unique loading - please contact us for more information!

Typ	Capacity	Division	Approval possible	Dim. mm	Article-No
KPZ 2-11-4	150 / 300 kg	50 / 100 g	No	905 x 505 mm	211403000000

KPZ price includes complete scale with indicator.

Option / extra charge	€/pcs	Artikel-Nr.
Stativ for KPZ 2-11-4		211400000100

24 months warranty

KPZ 502E-3, Scherstab-Wägezelle, legierter Stahl, IP68, C3
Shear beam load cell, alloy steel, IP68, C3
Tenzometrický snímač hmotnosti alloy steel, IP68, C3
Kapazität/Capacity/ Váživost : 250kg - 5000kg

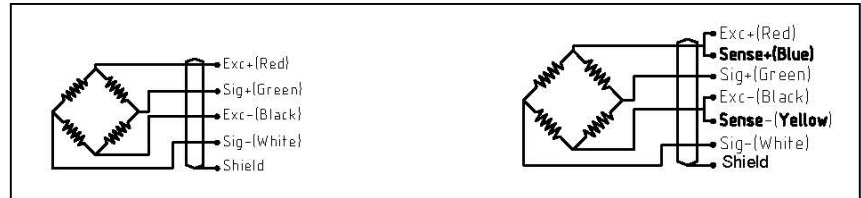
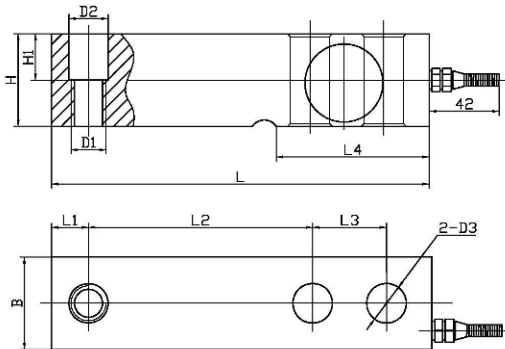

Abmessungen / dimensions:

		L	H	B	L1	L2	L3	L4	D3	H1	D2	D1
Kapazität / capacity												
250 – 2.500kg	mm	130,0	31,8	31,8	12,7	76,2	25,4	53,5	13,0	20,0	13,5	M 12 x 1,50
3.000 - 5000kg	mm	171,5	38,1	38,1	19,0	95,3	38,1	72,5	20,0	26	20,0	M 18 x 1,50

Technische Daten / specification:

Emax	t	0,25	0,5	1	1.5	2	2.5	3	5
Vmin	kg	0.02	0.05	0.1	0.15	0.2	0.25	0.3	0.5
Emin	kg	0							
Dmin	kg	0							
Humidity Class		CH							
Accuracy class		C3							
Zero balance	%F.S	±1							
Rated output	mV/V	3.0±0.0.003							
Y parameter		10000							
Z parameter		3000							
Resistance Input	Ω	400±10							
Output	Ω	352±3							
Insulation	MΩ	≥5000							
Safe load limit	%F.S	150							
Lateral load limit	%F.S	180							
Recommend excitaion	V.DC	10							
Maximum excitaion	V.DC	15							
Protection class		IP68							
Construction		Alloy steel							
Operating Temp Range	°C	-10~40							
Cable length	m	As per customers' requirements							

KPZ 502E-3, Scherstab-Wägezelle, legierter Stahl, IP68, C3
Shear beam load cell, alloy steel, IP68, C3
Tenzometrický snímač hmotnosti alloy steel, IP68, C3
Kapazität/Capacity/ Váživost : 7,5t – 10t

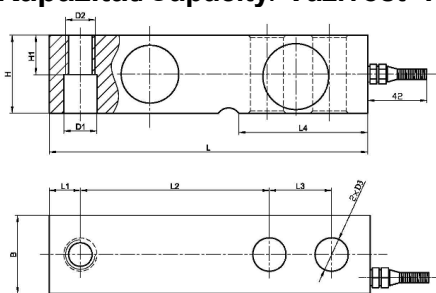



Abmessungen / dimensions:

Kapazität / capacity		L	H	B	L1	L2	L3	L4	D3	H1	D1	D2
7,5t – 10t	mm	225,5	50,8	50,8	25,3	124,0	50,8	102	27,0	25,4	27,0	M 24 x 2,0

Technische Daten / specification:

Emax	t	7.5	10
Vmin	kg	0.75	1.0
Emin	kg		0
Dmin	kg		100
Humidity Classification			CH
Accuracy class			C3
Zero balance	%F.S		±1
Rated output	mV/V		3.0±0.03
Y parameter			10000
Z parameter			3000
Resistance Input	Ω		400±20
Output	Ω		352±3
Insulation	MΩ		≥5000
Safe load limit	%F.S		150
Lateral load limit	%F.S		200
Recommend excitaion	V.DC		10
Maximum excitaion	V.DC		15
Protection class			IP68
Construction			Alloy Steel
Operating Temp Range	°C		-10~40
Cable length	m	As per customers' requirements	

KPZ 599-5, Bearing Foot for KPZ 502E-3 Shear Beam
 KPZ 599-5 Stabiler Fuß zur KPZ 502E-3 Scherstab-Wägezelle
 Stabilní nožička k KPZ 502E-3 shearbeam-snímač
 Selfleveling, chrome plated with adjustable thread M12 or M18
 Selbst nevlíerend mit Kugel, verchromt, mit Gewinde M 12 oder M18
 Samonastavovací s kuličkovým ložiskem, chromovaná se závitem M 12 nebo M 18

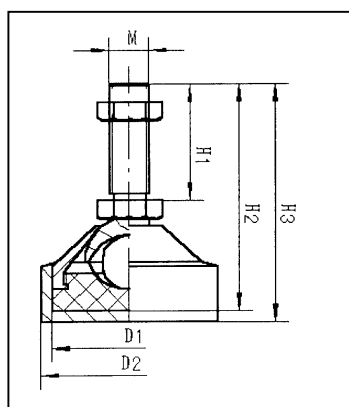
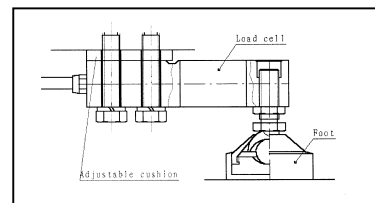



















Technical data							
Capacity	Art. number	D1	D2	H1	H2	H3	M
250 – 2.500kg	01052E302500	Ø54 mm	Ø62 mm	45 mm	85 mm	85 mm	M 12 x 1,75 mm
3.000 - 5000kg	01052E305000	Ø54 mm	Ø62 mm	60 mm	105 mm	110 mm	M 18 x 1,50 mm



Z0909000000
 Slučovací skříňka KPZ Z09-9, pro 4 tenzometry v robustním ABS pouzdře , s potentiometrem
 KPZ Z09-9, junction box, board with potentiometer, for up to 4 load cells, in ABS housing, with cable glands:
 Sammeldose KPZ 09-9, für 4 Wägezellen, im robustem Plasticgehäuse, mit Potentiometer.

KPZ 502E-3 Scherstab Wägezelle, Werkzeugstahl vernickelt, IP 68, Kap. 1000kg, Gewinde M12/M18, eichfähig C3
 KPZ 502E-3 share beam load cell, nickel plated steel, IP 68, Cap. 1000kg, approved C3, M12/M18 thread
 KPZ 502E-3 tenzometrický snímač, nástrojová ocel, pozinkovaný, IP 68, s polovičním dírovým závitem M 12/M18, cejchuschopný C 3,

Typ	Capacity/kg		Approval	Article No.
KPZ 502E3	250	alloy steel	YES/Ano/JA 	W052E3000250
KPZ 502E3	500	alloy steel	YES/Ano/JA 	W052E3000500
KPZ 502E3	1.000	alloy steel	YES/Ano/JA 	W052E3001000
KPZ 502E3	1.500	alloy steel	YES/Ano/JA 	W052E3001500
KPZ 502E3	2.000	alloy steel	YES/Ano/JA 	W052E3002000
KPZ 502E3	2.500	alloy steel	YES/Ano/JA 	W052E3002500
KPZ 502E3	3.000	alloy steel	YES/Ano/JA 	W052E3003000
KPZ 502E3	5.000	alloy steel	YES/Ano/JA 	W052E3005000
KPZ 502E3	7.500	alloy steel	YES/Ano/JA 	W052E3007500
KPZ 502E3	10.000	alloy steel	YES/Ano/JA 	W052E3010000
KPZ 502E3N	250	Stainless	YES/Ano/JA 	WN052E3000250
KPZ 502E3N	500	Stainless	YES/Ano/JA 	WN052E3000500
KPZ 502E3N	1.000	Stainless	YES/Ano/JA 	WN052E301000
KPZ 502E3N	1.500	Stainless	YES/Ano/JA 	WN052E301500
KPZ 502E3N	2.000	Stainless	YES/Ano/JA 	WN052E002000
KPZ 502E3N	2.500	Stainless	YES/Ano/JA 	WN052E002000
KPZ 502E3N	3.000	Stainless	YES/Ano/JA 	WN052E003000
KPZ 502E3N	5.000	Stainless	YES/Ano/JA 	WN052E005000
Feet	Fuß			
KPZ 599-5	250 – 2.500	Feet		010530023000
KPZ 599-5	3.000 - 5000	Feet		010530024000
KPZ 599-5	7.500 - 10000	Feet		010530025000
Junctionbox	Sammeldose			
KPZ Z09-9,				Z09090000000

Indicator Type	Article-Nr
Indicator KPZ 52E-8	Z52E8000000
Indicator KPZ 52E-8/1, with pre tare and easy counting	Z52E81000000
Indicator KPZ 56E-3, professional counting, addition, Tare input by hand	Z56E30000000
Indicator KPZ 56E-4, professional counting, addition, Tare input by hand, (frontpanel version)	Z56E40000000
Indicator KPZ 52-18	Z52180000000
Indicator KPZ 52-19 (forntpanel version)	Z52190000000
Indicator KPZ 52-7-2 (frontpanel version)	Z52720000000
Indicator KPZ 52E-9-1, Stainles steel housing (IP 67) easy counting	Z52E91000000
Indicator KPZ 51E-9-2, Stainles steel housing (IP 67), High/OK/LOW, 10 Memory	Z51E92000000

KPZ Indicators

 <p>KPZ 52E-7</p> <p>Klasse III M</p>	 <p>KPZ 52E-7/1</p> <p>Klasse III M</p>	 <p>KPZ 56E-4</p> <p>Klasse III M</p>
 <p>KPZ 52E-9-1</p> <p>Klasse III M</p>	 <p>KPZ 51E-9-2</p> <p>Klasse III M</p>	 <p>KPZ 51E11 - 13</p>
 <p>KPZ 58-2</p> <p>Klasse III M</p>	 <p>KPZ 52-19</p>	 <p>Big display/second display</p>
 <p>KPZ 54E-*</p> <p>Klasse III M</p>	 <p>KPZ 54E-*</p> <p>Klasse III M</p>	

KPZ Indikátory

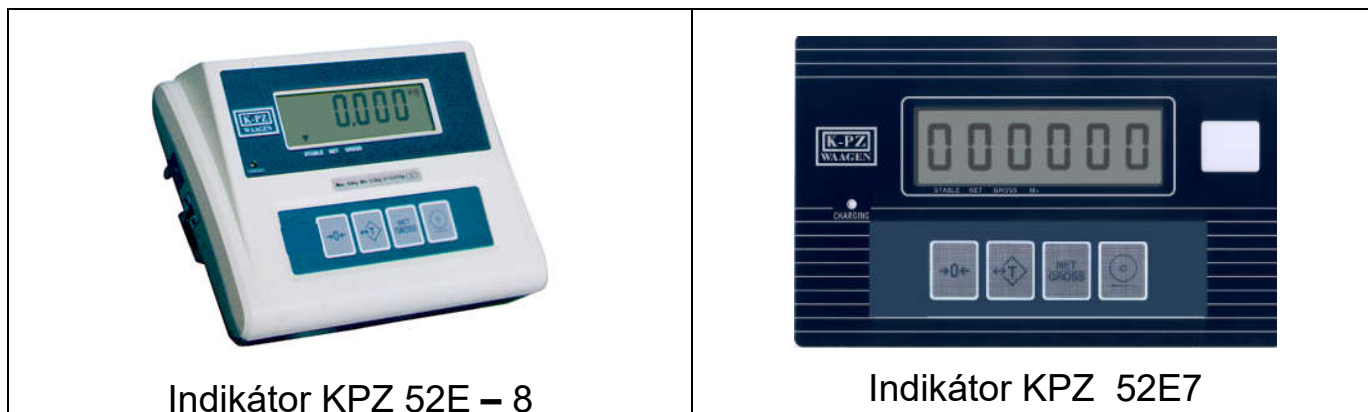

Klasse



Multirange division : See technical data of the scale. OIML Class

Description KPZ 52(E) - 7

Robust external case made from ABS incorporating a water-proof front keypad with large function keys. 6- digit, 26 mm high LCD – Display with back-light function providing a clear and easily readable weight indication. Operating temperature – 10 to + 40 °C. 230 Volt-operation.

Function : automatic and manual Zero setting. Tare setting up to 100 %, switch Net and gross weight repeatedly. Optional RS 232 Data output and addition sum printing, minus indication, LCD back-light (3 settings), audible/visible alarm/check HIGH-OK-LOW (That means two available value of weight), automatic selftest, Error message on display.

LED indication for : Zero, Tare weight, stabile, LOW Bat, power, addition memory.

Options: Configurable RS 232 output, data output (different formats), Roller printer, label printer, set point (High-OK-Low),

Key	Description
ON/OFF	This key is installed on the ABS housing. This key is used to switch the indicator ON or OFF. When activated the display shows the $\rightarrow 0 \leftarrow$ signal is on.
$\rightarrow 0 \leftarrow$	If the LCD Display is not indicating 0.00 , press this key to re-zero the scale. The display indicates that the ZERO signal is now on. The unit can zero $\pm 2\%$ of the max. capacity. Using this switch do not change the range of maximal capacity.
$\leftrightarrow T$	This key is used to carry out tare and zero settings, when an existing weight is on the scale. If a TARE weight is stored, the Tare Signal will indicate over Net . As soon as you remove the TARE weight re-set to ZERO by the user of the scale, the display shows the weight with a minus symbol in front on the LCD display. The maximum weighing range is reduced for the tare value. Tare capability is 100% of the scale capacity, and can be used repeatedly. Multiple tare is possible. Negative weight values can be moved to 0.00 .
NET GROSS	This key is used to switch between net and gross weight repeatedly. The display indicate Net or τ GROSS. This $\frac{NET}{GROSS}$ key can be used only when the scale is in the tare mode. By showing the Gross value (τ GROSS) the other keys are closed.
	If a printer interface is installed, this key will print out (printer version) or transfer the weight data being displayed . The weight value is stored in the data logger. The display indicate τ M+ .To print the grand total of all printed weights the weight must be removed. The display shows $\rightarrow 0 \leftarrow$. Then press the key twice the total sum of the weighing results will be printed .

KPZ Indicators





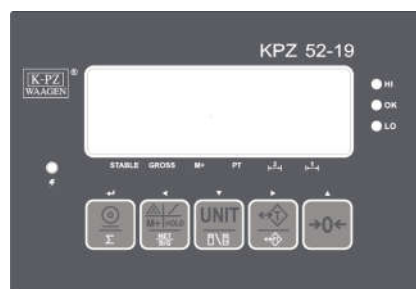



KPZ 52-18 Indicator

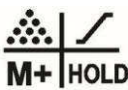

KPZ 52-19 Indicator

Robust external case including a water-proof front keypad with large function keys. 6-digit, 30 mm high LCD – Display with blue back-light function providing a clear and easily readable weight indication. Operating temperature – 10 to + 40 °C. 230 Volt-operation. Battery operation possible. **Function** : automatic and manual Zero setting. Tare setting up to 100 %, pretare function, switch Net and gross weight repeatedly. Optional RS 232 Data output and addition sum printing, minus indication, HIGH-OK-LOW function, totalizing function, automatic selftest, Error message on display. **LED indication for** : Zero, Tare weight, stable, LOW Bat, HI LOW OK .
Options: RS 232 output, data output, Roller printer,

Key	Function	Hold for 1 sec.
	Printout / data output (Option)	Communication settings
Σ	Totalizing	
	Modus selection / Function	/
	Switching between net and gross weight (net mode)	
UNIT	switching units	
	Switch between weight / unit weight (piece counting mode)	<ol style="list-style-type: none"> 1. Backlight 2. Switch on zero setting 3. Gravitation value
	Tare	
	Pretare	
	Zero	battery voltage



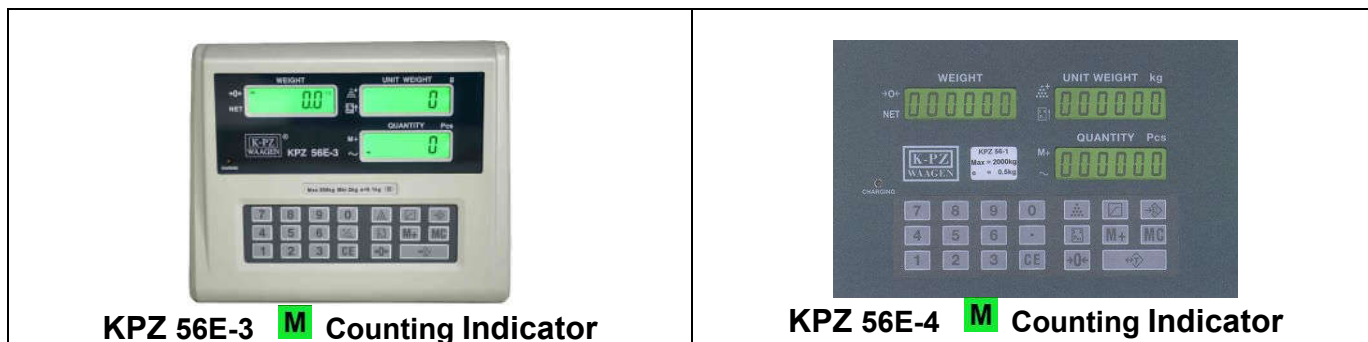

KPZ Indicators



Optimal unit weight for the piece count: 1/5 of the scale division.

This high-quality Parts Counting Indicator can be used in all types of uncertified and for trade weighing applications. Due to the high external resolution and the 20x expanded internal resolution, the unit is ideally suitable for both small and large item component counting. The expanded internal resolution of the indicator provides clear signal stability and repeatability. The 3 window highly visible LCD-Display provides the operator with clear data information. Additionally, with the robust construction of a steel housing, built-in rechargeable battery, and the simple to operate dust and waterproof front keypad, makes this part counting indicator a valuable tool for all industrial weighing & counting applications.

Description of Keypad

0 to 9 and .	Use to enter piece weight, total quantity or Tare value.
CE:	Deletes all value entered via the keypad.
→0←	1) Use this key to Zero the scale 2) Use this key by pressing twice to enter backlight options (see Backlight Function)
	Use this key to Tare the scale
	Use this key to confirm entered quantity.
	Use this key to confirm entered piece weight.
	Use this key to pre-set upper count limit, when the value is achieved an audible signal will be emitted.
	Use this key to save a piece weight in memory.
M+	Count accumulation key.
MC	Deletes all accumulation count in memory.

Standard features :Indicator: Display indication 1/30.000, internal divisions 1/600.000. Built-in calibration routine. Automatic & manual zero setting. 100% Tare. Piece Counting. The tare value and the piece weight can be weighed or entered via the front keyboard. The indicator has a 10 piece weight memory. 3 window LCD display with back-lighting option showing weight, quantity and individual piece weight. Counting accumulation. Audible peak alarm for Multi counting applications. Symbol indication shown at display for : Power re-charging control, LO-BAT. Zero, Tare, Stable, Memory, Piece number, Piece weight.

Options :

Factory configured serial interface (RS 232). With this interface in addition to date, weight & count information, two additional 15 character line entries can be included (for example Item number, operator number etc.) Printing from this interface via a single tally roll printer or label printer which will print all data in a numerical format, or in a range of standard **Barcodes**.

KPZ Indicators

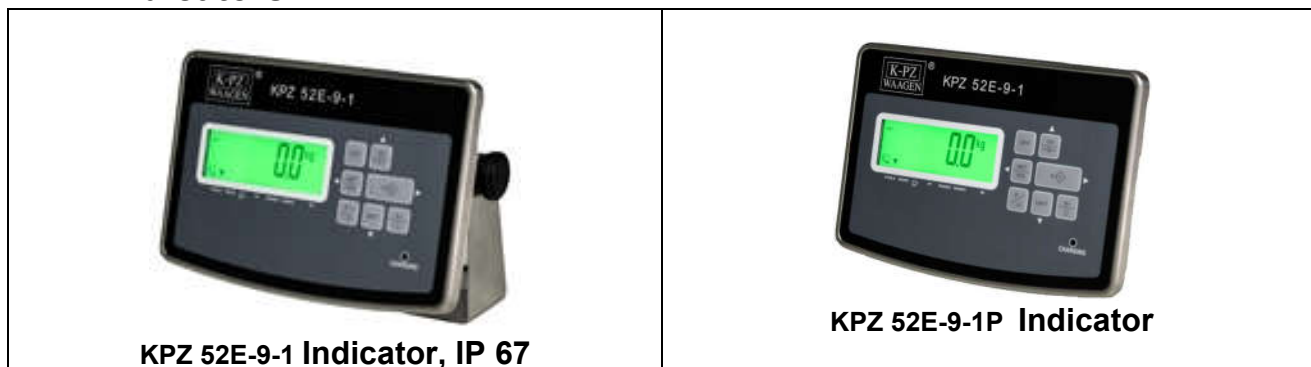

OIML trade approved Class III **M**, 10.000 e

Technical data: Indicator: **KPZ 52E-9-1** robust, stainless steel housing **IP 67**, user-friendly, large function keys. LCD display: 6 digit, various symbols, backlight, high of digits 25 mm. Operating temperature from -10°C up to +40°C, operation 230 Volt through external power supply, inbuilt battery (possibility of battery operation).

Functions: automatic and manual zero setting, switch Net/Gross weight, 100% tare, multiple tare, unit switching, simple piece counting by reference no. 10, 20, 50, 100 i 200. Possibility to enter data and bring out data through serial interface (optional): computer functional control, possibility of choosing different exit formats, **printout in simple format**, edition activation: via computer, continuously or after zero come back. Minus indication, LCD backlight, automatic shut off after 0-9 minutes, pre-set value control or limit value control LOW – OK - HIGH (any two weight values to choose, tone or light signal), electronic stabilization filter and signal distortion, automatic self test, error messages.

Indication: zero setting, gross, net, stability, LOW-Bat indication, pre-set/limit value, too small piece quantity or too small weight. **LED:** charging status. **Options:** serial interface RS 232, battery, label printer

Key functions:

Key	Description
ON	<i>switch the indicator ON</i>
→0←	<i>Switch the indicating to 0.00</i>
OFF	<i>switch the indicator OFF</i>
↔T	<i>TARE function</i>
NET GROSS	<i>Switch over Net / Gross Tare, repeatedly</i>
UNITS	<i>Switch over weighing units</i>
F/HR	<i>In approval version: High resolution indication (5 sec)</i>
M+	<i>Totalizing and printout/ data output</i>

Robust external case including a water-proof front keypad with large function keys. 6-digit, 30 mm high LCD – Display with blue back-light function providing a clear and easily readable weight indication. Operating



IP 67,

10 Setpoint memory
Tare setting by key,
Zero setting,
Alarm / check control setting,
back light LCD-Indicator,
Addition sum memory,
Multi range division,

OIML Class  **M** 10.000 e

Keypad :



Rear view and Dimension:

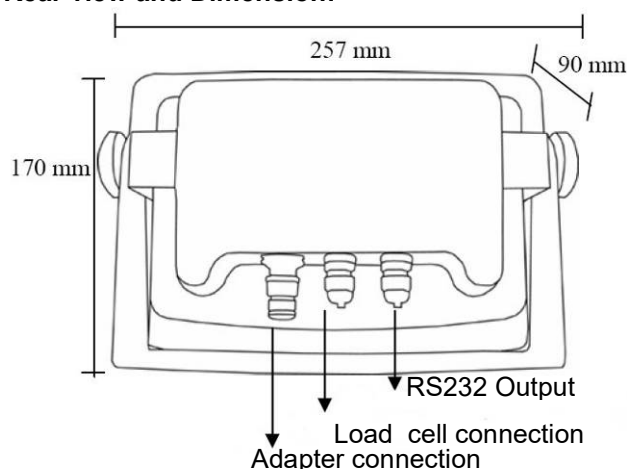

(For IP 67 use only cable diameter from 3 to 5,5mm)

Short description KPZ 51 E – 9 – 2 :

Case:

Compact, robust, high-quality stainless steel case **IP 67.** with hanger to the wall mounting or table mounting (optional stand possible), cable connecting by cable glands.

Indication and keyboard:

6-digit 25 mm high LCD – Display with back-light function providing a clear and easily readable weight indication, and a great, illuminated, coloured joist graphic display, membrane keypad with 16 buttons.

Symbol indication for : zero, tare, stable, LOW Bat, accumulator tension joist , check weighing HIGH-OK-LOW.

Basic functions:

automatic and manual Zero setting. Tare setting op to 100 %, Pretare, switch Net, tare and gross weight repeatedly. Target weight check tolerance with+(/), limit value control (limit = range of Low/Ok/High), 10 debit-/ limit value lofts. About parameter attitude: Percentage function, automatic switching off of backlight and electronics, interface functions and parameter.

Feature :

Multi range, selectable weighing unit, automatic zero correction, automatic shutoff 0-9 minutes, automatic. Backlight, digital stabilization and disturbance filters, measuring speed, gravitation zones, self-test function and error messages.

Energy:

internal accumulator, power supply unit of 230 VAC.

Certifications:

EU-calibrating admittance class  to 10,000 e.

Technical date:

Max . recommended external resolution 30,000 div, min . sensitiveness 0.3 μ V/d, supply voltage 5 VDC, zero input signal-1 to 5 mV, weight input signal-1 to 14 mV up to four 350 Ω load cells, linearity 0.01% F.S.,operating temperature-10 to +40° C. **ptions:** Configurable RS 232 output, data output (different formats), Roller printer, label printer, set point (High-OK-Low),

Extended functions and optional possibilities (surcharge):

Connection:

Serial interface RS232 bidirectional, data output format and mode choice, factory programmable format, date and time, relay exit for alarm/check points.

KPZ 54-* / Touch screen indicator



- Touch Operating System for user friendly and fastest operations.
- Multi-printer selectable
- Custom printout options,
- Multi -language support
- Report management.
- PC keyboard and Mouse can be connected
- Software upgrade option.
- 9999 products possible to store in memory.
- designed for multiple use, such as Weighing, Target, Counting, Check weighing and Recipe operations.
- 2xUSB port, 1xRS232, optional more ports possible
- 7' or 8' display possible
- Robust ABS or stainless steel housing possible
- Dual scale option (extra charge) possibility



KPZ 51E-45K

IP69K

AISI 304 stainless steel weight Indicator (dimensions: 206x286x108 mm) with 6 PG9 cable glands, **IP69K protection rating**, stainless steel adjustable bracket included (overall dimensions with bracket: 206x290x187 mm). Optionals: panel / desk / column mounting. Six-key membrane keyboard with buzzer. Real-time clock with buffer battery.

Weight reading by another instrument via serial port.

Two serial ports (RS232 and RS485) for connection to:

- PC/PLC up to 32 instruments (max 99 with line repeaters) by ASCII protocol or ModBus RTU.
- Remote display.
- Printer.
- Optional integrated output: Profibus DP, DeviceNet, CANopen, Profinet IO, Ethernet/IP, Ethernet TCP/IP, Modbus/TCP.

Main functions:

- 5 setpoints (4 setpoints if Analog Output is present) configurable as normally open or normally closed. The operator can decide the setpoints activation for the net weight value, gross weight value, otherwise for positive weights or for positive and negative weights.
- Counting.
- Totalizing.
- Setting of hysteresis value for each setpoint.
- 12 groups selection by 5 setpoint from selector switch or contacts (EC/E options).
- Peak holder displaying by closing the Peak contact.
- Net/Gross function by keyboard or external contact.
- Manual adjustment of zero value in case of zero-setting not possible.
- Auto zero function.
- Auto zero-tracking function.
- Print of the weight via keyboard or external contact with date and time.

Operation: The inputs can work as: net/gross weight, zero-setting, peak, print or can be remotely read via protocol.

The outputs can work as setpoints or can be remotely switched via protocol.

Weight transmitter approved OIML R61 (Automatic Gravimetric Filling Instruments) according to WELMEC Guide 8.8:2011 (MID).

approvable EN45501-2014/31/UE-OIML R76:2006

- Maximum number of verification scale intervals n=10000
- Minimum input-voltage per VSI 0.2 µV
- Weighing range single range or multi range (max 3) or multi interval (max 3)
- Calibration via keyboard is protected through seals for the access to a setting jumper or installer password
- Semi-automatic zero and tare, predetermined tare functions.
- Weight subdivisions displaying (1/10 e)
- The following values can be printed from external contact: net/gross weight; tare; predetermined tare; date; time; ID code (if alibi memory is present)



KPZ 51E-41 indicator

Characteristics:

Software: Base

- Zeroing
- Tare
- Hand tare
- Gross / Net switching
- simple piece counting
- Add function
- automatic zeroing function

Function (Optional):

- Print function including date and time, external button
- I / O inputs as net / gross switching, zeroing, peak value, printout
- I / O outputs as set point function
- Communication protocol via serial interface
- 5 set points (4 set points if analogue output is available) Configurable as open or normally closed. The set points can be set as net weight, gross weight, for positive or for positive and negative weights.
- Setting the hysteresis value for each set point.

Option (extra charge):

- Wall mounting
- Stand
- Battery
- Alibi memory
- Analog output
- I/O's, relay output
- Printer
- Serial interface RS232 and RS485
- Remote display
- Profibus, Ethernet TCP/IP, Modbus, CANopen, DeviceNet.

Power supply:

- Mains 110-240VAC, 3m long cable

Technical Data:

- LCD display, backlit (6 digit 20mm high, semi alphanumeric)
- 16 icon displays
- Robust ABS housing IP67
- Temperature range: -10 ° C to 40 ° C
- dim. 122x226x164mm
- EU type approval Class III to 10,000e

Big display (second display), can be combined with all KPZ Indicator

Model : KPZ GD 1-1

150057052000 Large display KPZ GD1-1, 6-digit, 127 mm LED dot matrix, with 5m connection cable and interface for connection to the display KPZ 52 (E) - *

Model : KPZ GD 2

150057062000 Großanzeige KPZ GD2-1 6-stellig, 76 mm LED's dot Matrix, mit 5m Anschlußkabel und Interface zum Anschluß an die Anzeige KPZ 52 (E)-*



PC Software K-PZ Smart Scale

Software K-PZ Smart Scale is a modern software specially designed to manage weighing data. A custom function selection is possible depending on different stages of development. Moreover, it is possible to customize software according to customer requirements.

It provides an extremely user-friendly interface and easy of operation.

Software used to manage weighing data, transmitted via the interface of the scale.

It saves time and transmission errors that may occur by manual data input.

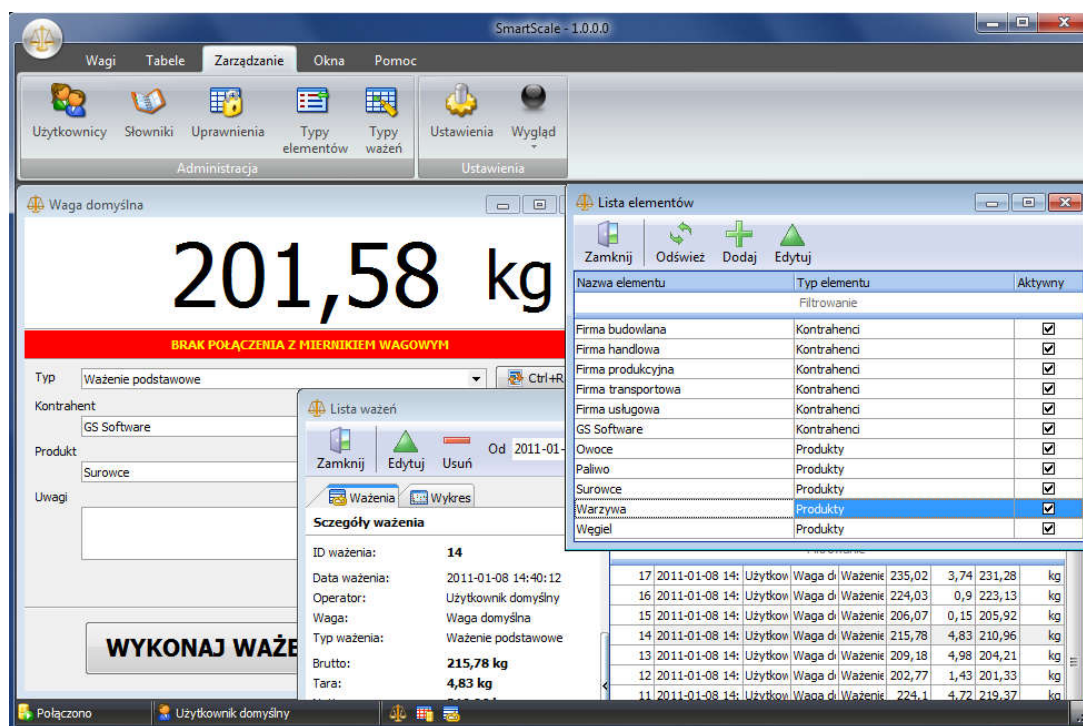

View of the main window

Depending on the configuration following option possible :

- Adjustment of customer-specific data
- Admin data managing
- User managing
- Export to TXT, CSV, RTF, JPG, XLS file
- Print out
- Label printing

Software comes with a USB flash drive activation key.

system Requirements:

Minimum requirements:

- hardware – Processor Intel Pentium 4, 512 MB RAM, 100 MB of the hard drive free;
- software: Windows 2000 (SP4), XP (SP2), Vista, Win7

Depending on version of KPZ Smart Scale , the following functionality is possible:

Function	Programm version		
	Standard	Professional	Premium
Facility to connect only one scale indicator	X		
Facility to connect any number of indicators the same time		X	X
Handling any model of KPZ indicator	X	X	X
Access to weighing list data window	X	X	X
Export weighing list data to the .TXT or .CSV file	X	X	X
Export weighing list data to the .XLS file (installation of MS Excel not necessary)		X	X
Weighing list data overview on the chart	X	X	X
Save the chart (weighing list data) as a picture	X	X	X
Weighing search	X	X	X
Weighing ticket preview	X	X	X
Save weighing ticket as PDF file	X	X	X
Edit data assigned to the weighing	X	X	X
History of weighing changes preview			X
Access to the Report Generator		X	X
Generating report to any data		X	X
Save the report as .PDF file		X	X
Export report data to .RTF, .CSV, .JPEG, XLS file (installation of MS Excel is necessary)		X	X
Export report data to . XLS file (installation of MS Excel not necessary)			X
Using programm as default user (with out Log in-Panel)	X		
Using programm as defined User or Admin		X	X
User Authorization Management			X
Facility to perform weighing without additional data	X	X	X
Facility to perform weighing with additional data: contractor, product, comments,	X	X	X
Facility to perform weighing with additional data: contractor, product, comments, + 2 additional dictionaries, + 2 additional text fields		X	X
Facility to perform weighting with any data type. Possibility to build any data structure.			X
Access to the window allowing to create dictionaries in a database			X
Network version		X	X
Print out as graphic or text mode	X	X	X
Facility to print out the logo on the ticket weighting (graphic mode)	X	X	X
Facility to create license data (one set only)	X		
Facility to create any number of license data set		X	X
Virtual Scales mechanism (planned)		X	X
Label ticket operation (planned)		X	X
Multi-language	X	X	X

Printers for KPZ scales

More printers and options on request!

Thermal printer Favorit 24	
Dimensions	85 x 85,5 mm (B x H)
Own weight	150 g
Power supply	Scale's battery
Interface	serial RS232
Version	Thermo-Direkt-Drucker, 203 dpi,
Paper	Paper width: 57 mm



Ticket printer DR 2	
Dimensions	93x173x190 mm (B x H x T)
Own weight	1,2 kg
Power supply	230 VAC / 20 V DC 2,5 A
Interface	serial RS232, Parallel
Version	Thermo-Direkt-Drucker, 203 dpi,
Paper	Etiquette width : max 61mm



Ticket printer DR 6	
Dimensions	ca. 109 x 171 x 209 mm (B x H x T)
Own weight	ca. 1,2 kg
Power supply	100-240 VAC / 24 VDC 2,1 A
Interface	seriell RS232, Parallel
Version	Thermo-Direkt-Drucker, 203 dpi,
Paper	Etiquette width: 15-60mm



Thermal printer Favorit	
Dimensions	85 x 85,5 mm (B x H)
Own weight	150 g
Power supply	Scale's battery
Interface	serial RS232
Version	Thermo-Direkt-Drucker, 203 dpi,
Paper	Paper width: 57 mm



Rollerprinter DR 7	NEW
Dimensions	110 x 125 x 70 mm (B x H x T)
Own weight	600 g
Power supply	230 VAC / 9 V DC 3,2 A
Interface	RS232, USB
Version	Thermo-Direkt
Paper	Papierbreite: 58mm, 20m, Ø40mm



Rollerprinter DR 7	
Dimensions	160 x 139 x 248 mm (B x H x T)
Own weight	2,3 kg
Power supply	230 VAC / 20 V DC 2,5 A
Interface	serial RS232, Parallel
Version	9- Needle printer, alphanumerischer Ausdruck
Paper	Paper width: 76 , 69,5 or 57,5 mm max. 40 digits on column



K-PZ Waagen
 Kanalsteck 9
 21129 Hamburg
 Tel. 040 / 742174-0
 Fax 040 / 742174-99
 TICKET NO. 1
 Art.-Nr.: 123456
 PCS 40
 APW 100 g
 G 5.001 kg
 T 1.000 kg
 N 4.001 kg



KPZ 719SJDR
 Exemplary formats
 Indikátor KPZ 52 19



TICKET NO.0001
 GS 124.5 kg
 TR 20.0 kg
 NT 104.5 kg

TICKET NO.0002
 GS 124.0 kg
 TR 20.0 kg
 NT 104.0 kg

TOTAL NUMBER
 OF TICKETS 0002
 TOTAL WEIGHT
 248.5 kg

Indicator KPZ 5218



23/08/2016, 16:42:45

TICKET NO.0001
 G 2.0kg
 T 0.0kg
 N 2.0kg

23/08/2016, 16:43:01

TICKET NO.0002
 G 5.6kg
 T 0.0kg
 N 5.6kg

23/08/2016, 16:43:13

TOTAL NUMBER
 OF TICKETS 0002
 TOTAL
 NET 7.6kg

KPZ printers

Exemplary formats / Indicator KPZ 52(E) – 7 / Indicator KPZ 52(E) - 8

Examples are standard formats to printers KPZ. Possibility computer formats. Possibility of formats on customer request!

Exemplary print out Simple format 3	
S/N	WT/kg
0001	100,0
0002	200,0
0003	300,0
0003	600,0

Exemplary print out Complete format 4	
TICKET NO.0001	
G	100,0g
T	0,0g
N	100,0g
TICKET NO.0002	
G	200,0g
T	0,0g
N	200,0g
TICKET NO.0003	
G	300,0g
T	0,0g
N	300,0g
TOTAL NUMBER OF TICKETS 0003	
TOTAL	
NET	600,0g

G = Gross
T = Tare
N = Netto

Exemplary print out Stable format 5	
S/N	WT/kg
0001	100,0
0002	200,0
0003	300,0
0003	600,0

KPZ printers

Exemplary formats / Indicator KPZ 56-3/ KPZ 56-4 / KPZ 2-04-7 scale

Examples are the standard formats. Other formats are possible on request.

Example - format 1:

20.000	kg
7.975	kg
12.125	kg
13.380	kg

Example - format 2:

Ticket NO.	1	
Q'TY	40	PCS
APW	100	g
G/B	5.000	kg
T	1.000	kg
N	4.000	kg

Ticket NO.	2	
Q'TY	290	PCS
APW	100	g
G/B	30.000	kg
T	1.000	kg
N	29.000	kg

TOTAL TICKETS:	2
TOTAL Q'TY:	330 PCS

Example - format 4:

S/N	WT/kg	PCS
1.	20.000	3333
2.	20.000	3333
3.	8.000	1333
3/	TOTAL	Q'TY:
	7999	PCS

Example - format 3:

Date:	03-03-00	
Time:	09:04:43	
ID#:	123456789012345	
Part#:	543210987654321	
Ticket NO.	1	
Q'TY	40	PCS
APW	100	g
G/B	5.000	kg
T	1.000	kg
N	4.000	kg

Date:	03-03-00	
Time:	09:04:43	
ID#:	123456789012345	
Part#:	543210987654321	
Ticket NO.	2	
Q'TY	290	PCS
APW	100	g
G/B	30.000	kg
T	1.000	kg
N	29.000	kg

TOTAL TICKETS:	2
TOTAL Q'TY:	330 PCS

Example - format 5:

Date:	03-03-00	
Time:	09:04:43	
ID#:	123456789012345	
Part#:	543210987654321	
S/N	WT/kg	PCS
1.	20.000	3333
2.	20.000	3333
3.	8.000	1333
3/	TOTAL	Q'TY:
	7999	PCS

Printing formats

Indicator KPZ 56E-3 / KPZ 56E-4

Scale KPZ 2-04E-7

inkl. PT and Addition

standard format

NO.	1
G	276.7 kg
T	104.5 kg
PT	22.2 kg
N	150.0 kg
U/W	12 kg
PCS	13 pcs

NO.	2
G	176.7 kg
T	104.5 kg
PT	22.2 kg
N	50.0 kg
U/W	12 kg
PCS	4 pcs

=====	
T/N	2
T/W	200.0 kg
T/A	17 pcs

PT = Pretare

U/W = Unit Weight

PCS = Quantity

T/N = Total weighings

T/W= Total Netto weight

T/A= Total quantity

Indicator KPZ 51E-9-2

Example - format 1:

DATE:	03/03/2000
TIME:	09:04:43
TICKET NO.	01
NET:	+ 4.500 kg
GROSS:	+ 6.000 kg
TARE:	+ 1.000 kg
PRETARE:	+ 0.500 kg

DATE:	03/03/2000
TIME:	09:04:55
TICKET NO.	02
NET:	+ 5.500 kg
GROSS:	+ 6.000 kg
TARE:	+ 0.000 kg
PRETARE:	+ 0.500 kg

DATE:	03/03/2000
TIME:	09:05:35
TOTAL NO.	02
TOTAL NET:	+ 5.500 kg



KPZ 2-11-3 



KPZ 2-02-4 





KPZ 2-03-10  IP 65



KPZ 2-04-7 



KPZ 2E-06S  



KPZ 2114



KPZ 2082 Dual counting System



KPZ 1  



KPZ 1 B 



KPZ 2B 



KPZ 2S 



KPZ 2ECO 





Drive through Scale



KPZ 2D  



KPZ 71-*  



Stainless Steel DIN 1.4301, extrem solid and stable construction, IP 67, 68 and 69K



KPZ 72  



KPZ 73B



KPZ 73SDJ



KPZ 73 



KPZ 74 



KPZ 70 weighing forks



KPZ 39
 Hydraulic Forklift scale



Crane scale 



Coil Scale



Animal scale 



Silo weighing

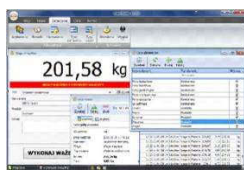



KPZ PC Software



Special models are our speciality!

Mobile KPZ scales



KPZ 71-7   
Many Option possible



Option KPZ 71-7



KPZ 71-8 
2.200kg / 200g



KPZ 71-9
2.200kg / 500g

KPZ 72



KPZ 72, 2400mm, 3200kg



KPZ 73 



KPZ 73 SDJ 



KPZ 73 B 



KPZ 74 



Weighing forks Forklift truck scale



KPZ 39
Electronic – Hydraulic version



Touch sreen Indicator 7-Zoll



Scale for Coil's



German design and own EU production guarantees high quality.

Stainless steel Material : DIN 1.4301 / 1.4541 / 1.4404

KPZ-Waagen, Stainless steel scale and Indicator, IP 67/68/69K



Platform Scale KPZ 2N, Stainless steel, IP 67/68/69 K

Stainless steel Material : DIN 1.4301 / 1.4541 / 1.4404

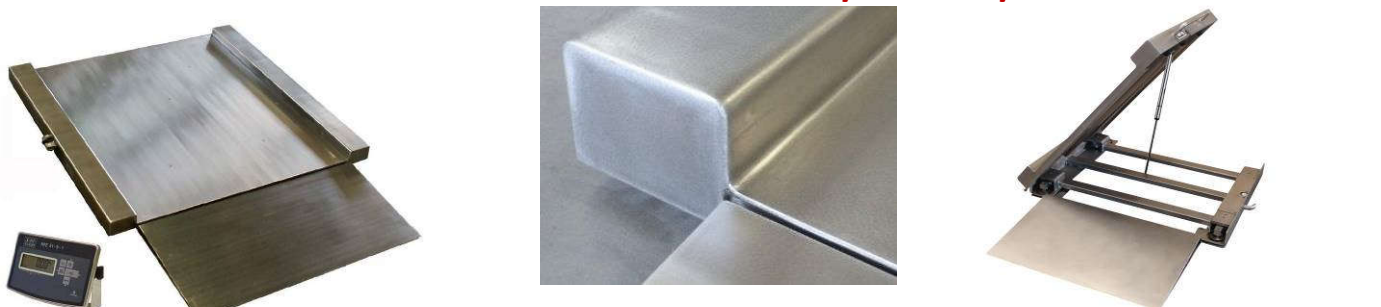

Low construction scale KPZ 2DN

Plain, top plate of platform made of one piece. IP 67/68/69K

Stainless steel Material : DIN 1.4301 / 1.4541 / 1.4404



**Pallet weigher Type: KPZ 71-7N
stainless steel DIN 1.430, IP 67/68/69K**

**Pallet scale KPZ 1N, IP 67/68/69K
Stainless steel - Material 1.4301**



**Bench Scale KPZ 2E-06, stainless steel DIN 1.430, IP 67/68, IP 69K
German design and own EU production guarantees high quality.**

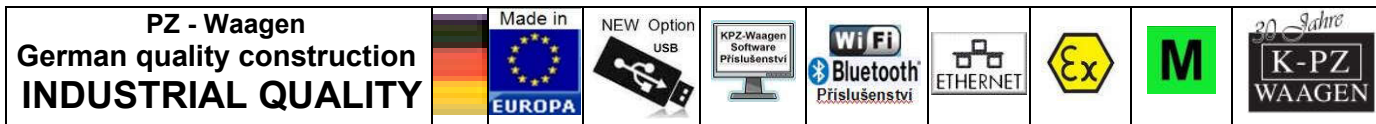

200305 00 N UK €



KPZ - Váhy, s. r. o.

Libošovice 76,
CZ 507 44 Libošovice

Tel.:

+420 736 622 710

+48 661 033 820

+420 493 571 111

email: / zander@kpzwaagen.de / kpz@kpz-vahy.cz

www.kpzwaagen.com